



FICHA TÉCNICA

Producto: **Sopladora Total Tools 400W**

DESCRIPCIÓN: Sopladora Total Tools de 400W de potencia y un voltaje de 110-120V~50/60Hz. Velocidad sin carga de 14.000/min y su velocidad máxima de soplado es 3.0 m³/min. Incluye: bolsa de polvo y tubo de soplado. Su peso es de 1.5 Kg. y posee garantía de 6 meses.

CÓDIGO: UTB2046

Marca: Total Tools	Incluye: bolsa de polvo y tubo de soplado
Voltaje: 110-120V~50/60Hz	Peso: 1.5 Kg.
Potencia: 400W	Garantía: 6 meses
Velocidad sin carga: 14.000/min	Procedencia: Importado
Velocidad máx. de soplado: 3.0 m ³ /min	

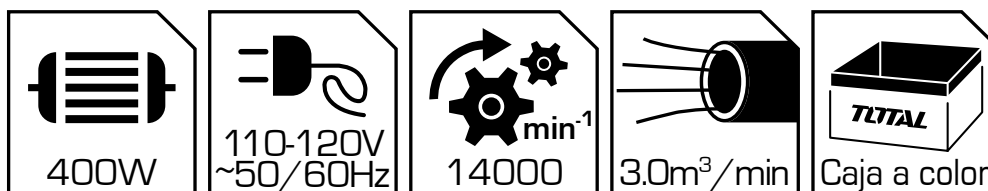

TOTAL

One-Stop Tools Station

TOTAL

ASPIRATOR BLOWER

TB2046, UTB2046, TB2046-4
TB2046-6, TB2046S, TB2046-8









EN Aspirator Blower

ES Aspirador Soplador



400W

The symbols in instruction manual and the label on the tool

	Double insulated for additional protection.
	Read the instruction manual before using.
	CE conformity.
	Wear safety glasses, hearing protection and dust mask.
	Waste electrical products should not be disposed of with household waste. Please recycle where facilities exist. Check with your Local Authority or retailer for recycling advice.
	Safety alert. Please only use the accessories supported by the manufacture.

SAFETY INSTRUCTION

Warning! Read all instructions. Failure to follow all instructions listed below may result in electric shock, fire and/or serious injury. The term "power tool" in all of the warnings listed below refers to your mains operated (corded) power tool or battery operated (cordless) power tool. **SAVE THESE INSTRUCTIONS.**

1) Training

- Read the instructions carefully. Be familiar with the controls and the proper use of the machine.
- Never allow children to use the machine.
- Never allow people unfamiliar with these instructions to use the machine. Local regulations may restrict the age of the operator.
- Never operate the machine while people, especially children, or pets are nearby.
- The operator or user is responsible for accidents or hazards occurring to other people or their property.

2) Preparation

- While operating the machine, always wear substantial footwear and long trousers.
- Do not wear loose clothing or jewellery that can be drawn into the air inlet. Keep long hair away from the air inlets.
- Wear protective goggles while operating
- To prevent dust irritation the wearing of a face mask is recommended
- Before using, check the supply and extension cord for signs of damage and aging. Do not use the machine if the cord is damaged or worn.
- Never operate the machine with defective guards or shields, or without safety devices, for example debris collector in place.
- Only use a weather proof extension cable fitted with a coupler according to IEC 60320-2-3.

3) Operation

- Always direct the cable to the rear away from the machine.
- If a cord becomes damaged during use, disconnect the supply cord from the mains immediately. **DO NOT TOUCH THE CORD BEFORE DISCONNECTING THE SUPPLY.**
- Do not carry the machine by the cable.
- Disconnect the machine from the mains supply
 - Whenever you leave the machine.
 - Before clearing a blockage.
 - Before checking, cleaning or working on the machine.
 - If the machine starts to vibrate abnormally.
- Operate the machine only in daylight or in good artificial light.
- Do not overreach and keep your balance at all times.
- Always be sure of your footing on slopes.
- Walk, never run.
- Keep all cooling air inlets clear of debris.
- Never blow debris in the direction of bystanders.
- Recommendation to operate the machine only at reasonable hours-not early in the morning or late at night when at night when people might be disturbed.
- Recommendation to use rakes and brooms to loosen debris before blowing/vacuuming.
- Recommendation to slightly dampen surfaces in dusty conditions or use mister attachment.
- Recommendation to use the full blower nozzle extension so the air stream can work close to the ground

4) Maintenance and storage

- Keep all nuts, bolts and screws tight to be sure the machine is in safe working condition.
- Check the debris collector frequently for wear or deterioration.
- Replace worn or damaged parts.
- Use only genuine replacement parts and accessories.
- Store the machine only in a dry place.

Recommendations:

- to connect the machine only to a supply circuit protected by a residual current device (RCD) with a tripping current of not more than 30 mA for mains powered machines.
- to avoid using the machine in bad weather conditions especially when there is a risk of lightning.

Supply cords shall not be lighter than:

- if rubber insulated, ordinary tough rubber sheathed flexible cord (code designation H05 RN-F)
- if polyvinyl chloride insulated, ordinary polyvinyl chloride sheathed flexible cord (code designation H05 VV-F)

Other information for correct and safe use

While using electrical appliances, in order to reduce the risk of fire, electric shock, and/or injury to persons, basic safety precautions should be followed, including the following:

- Read all instructions carefully, even if you are familiar with the appliance.
- For type Y attachment, if the supply cord is damaged, it must be replaced by the manufacturer, its service agent or similarly qualified persons in order to avoid a hazard.
- To protect against the risk of electric shock, DO NOT IMMERSER the appliance, cord set or plug in water or other liquids.
- To clean, wipe the exterior with a damp cloth.
- Close supervision is necessary when any appliance is used near children. Never leave an appliance unattended when in use.
- Switch off and remove the plug from the power outlet when not in use before assembling or disassembling parts, cleaning or carrying out any maintenance of the appliance. Never pull the cord while unplugging out from power outlet.
- Do not operate the appliance if its damaged in any manner. Return the complete appliance to your nearest authorized service facility for examination, electrical repair, mechanical repair or adjustments to avoid any hazard.
- The use of attachments or accessories not recommended or sold by this appliance manufacturer may result in fire, electric shock or personal injury.
- Do not let the cord hang over the edge of a table, counter, or touch hot surfaces.
- Avoid touching hot surfaces, use handles and knobs.
- Do not operate or place any part of this appliance on or near any hot surfaces (such as gas or electric burner or in a heated oven).
- Do not abuse the cord, Never carry the appliance by the cord or yank it to disconnect it from the outlet; instead, grasp the plug and pull to disconnect.
- When using an extension cord with your appliance, make sure the extension cord is correctly wired, and rated for its use.
- This product is intended for household use only.
- Do not attempt to repair the appliance yourself; instead, take it to your Manufacturer-owned or Authorized Service Centre for repair.
- Warning! Fan continue to rotate after the motor is switch off
- Work of maintenance and cleaning on the appliance only with the motor stopped and the mains plug disconnected

- Do not block the blower opening or intake. Blocking the blower opening will cause an increase in the motor rotation speed abnormally and might damage the vanes on the inner section of the unit or cause injuries. The motor might also overheat and cause a fire.
- Do not collect still smoldering cigarette ashes, freshly cut metals shaving, screws, nails and the like.

Intended use

Your Blower has been designed for garden and indoor use for blowing & cleaning applications, as well as light suction purpose.

Warning Symbols



Read the operation manual and follow all warnings and safety instructions.



Switch off and remove plug from mains before cleaning or maintenance



Do not use your saw in wet conditions or expose it to rain.



Disconnect the mains plug if the cord becomes damaged or entangled



Always wear eye protection.



Always wear ear protection.



Beware of falling objects.



Do not touch the fan. The tines will continue to rotate for a short time after switch off.



Keep bystanders away.



Conformance complies with Europe relevant standards.



Meaning of crossed –out wheeled dustbin:
Do not dispose of electrical appliances as unsorted municipal waste, use separate collection facilities.

Electrical safety



This tool is double insulated; therefore no earth wire is required. Always check that the power supply corresponds to the voltage on the rating plate.

Parts Identification

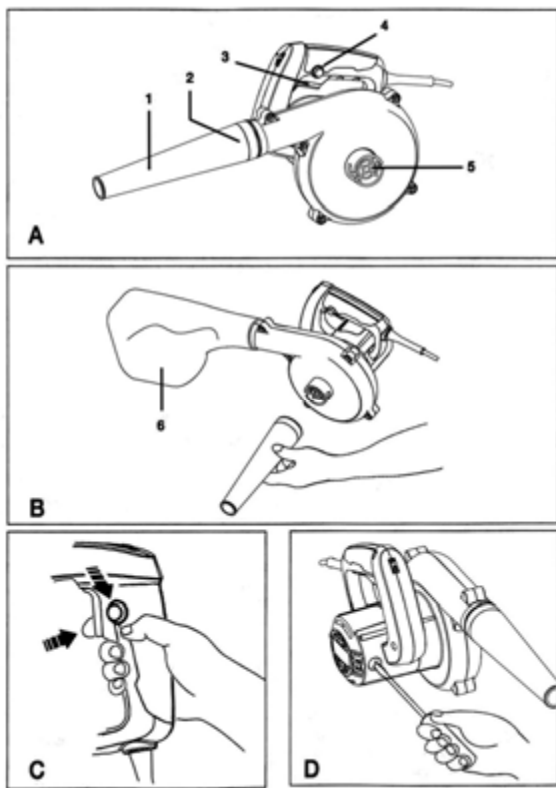

1. Nozzle
2. Blast Port
3. Trigger Switch
4. Lock-On Button
5. Suction Port
6. Dust Bag

Intended use

Your Blower has been designed for blowing & cleaning applications, as well as light suction purpose.

Maintenance

Your tool has been designed to operate over a long period of time with a minimum of maintenance. Continuous satisfactory operation depends upon proper tool care and regular cleaning.

Warning! Before performing any maintenance, switch off and unplug the tool.

- Regularly clean the ventilation slots in your tool using a soft brush or dry cloth.
- Regularly clean the motor housing using a damp cloth. Do not use any abrasive or solvent-based cleaner.

Technical data

Model:	TB2046	UTB2046
Rated voltage:	220-240V~50/60Hz	110-120V~50,60Hz
Rated power input:	400W	400W
No-load speed:	14000/min	14000/min
Max. blowing rate:	3.0m ³ /min	3.0m ³ /min
Insulation class:	□	□
Sound pressure level (according to IEC 60745):	90 dB (A)	90 dB (A)
Sound power level (according to IEC 60745):	100 dB (A)	100 dB (A)
Vibration level (according to IEC 60745):	≤ 2.5 m/s ²	≤ 2.5 m/s ²
Weight:	1.45 kg	1.45 kg

Model:	TB2046-4 (IRAM Plug)	TB2046-6 (ISRAEL Plug)	TB2046-8 (BS Plug)	TB2046S (SAA Plug)
Rated voltage:	220-240V~50/60Hz			
Rated power input:	400W			
No-load speed:	14000/min			
Max. blowing rate:	3.0m ³ /min			
Insulation class:	□			
Sound pressure level (according to IEC 60745):	90 dB (A)			
Sound power level (according to IEC 60745):	100 dB (A)			
Vibration level (according to IEC 60745):	≤ 2.5 m/s ²			
Weight:	1.45 kg			

TB2046, UTB2046, TB2046-4, TB2046-6 TB2046-8, TB2046S Exploding view

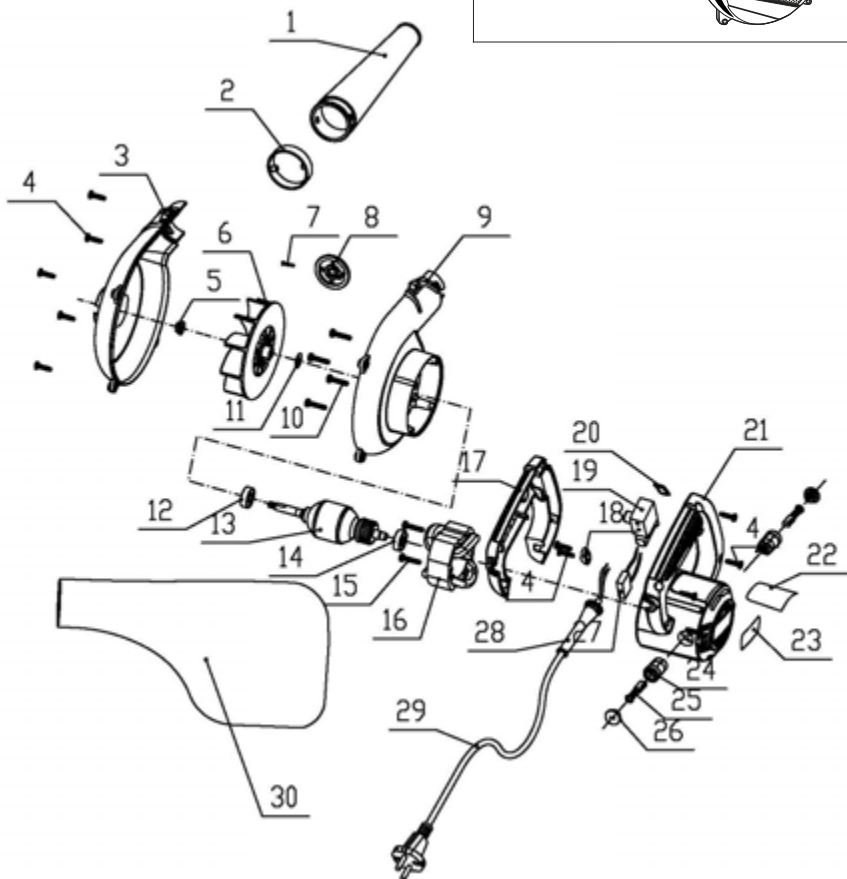
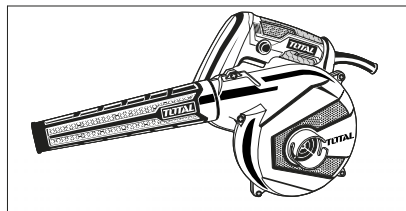

**TB2046,UTB2046,TB2046-4,TB2046-6,TB2046-8,
TB2046S**

Spare part list

No	Part Description	QTY	No	Part Description	QTY
1	Wind pipe	1	16	Stator	1
2	Wind pipe ring	1	17	Handle cover	1
3	Left wind housing	1	18	Cord clamp	1
4	Tapping Screw	11	19	Switch	1
5	Nut	1	20	Adorn block/PCB	1
6	Fan	1	21	Motor mounting	1
7	Tapping Screw	1	22	Detail label	1
8	Back plate	1	23	Logo label	1
9	Right wind housing	1	24	Brush holder	2
10	Tapping Screw	4	25	Carbon Brush	2
11	Pan washer	1	26	brush cover	2
12	Bearing	1	27	Condenser	1
13	Armature	1	28	Cord Jacket	1
14	Ball Bearing	1	29	Cord plug	1
15	Tapping Screw	2	30	Dust bag Ass'y	1

TOTAL

One-Stop Tools Station

TOTAL

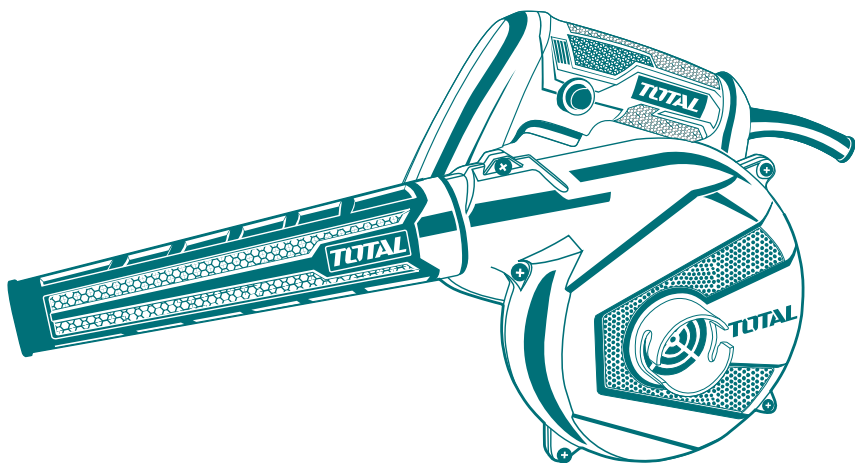

ASPIRATOR BLOWER

www.totaltools.cn
TOTAL TOOLS CO., PTE. LTD.
MADE IN CHINA
T118.V05

400W