



# Benelli

TRK 502/TRK 502X USER'S MANUAL

## CONTENTS

CONTENTS .....	2
Special Reminding .....	5
Preface .....	6
Safety Notes .....	7
● Safety Driving Rules .....	7
● Protection Clothes .....	9
Serial Number .....	10
Location of Parts .....	11
● Meter & Indicator .....	13
Primary Parts .....	15
● Key switch .....	16
● Left Handle .....	16
● Right Handle .....	21
● Fuel Tank .....	22
● Rear Shock Absorber .....	23
● Rear Brake Pedal .....	24



**Benelli**

TRK 502/ 502X

PURE PASSION SINCE 1911 

## CONTENTS

● Shift Pedal .....	24
● Tool Bag .....	25
Notice of Use of Fuel and Engine Oil .....	25
Running In .....	26
Inspection before Driving .....	27
● How to start the engine .....	28
● Smooth launching .....	29
● To change gear .....	30
Inspection & Maintenance .....	30
● Maintenance Schedule .....	30
● Oil Level & Oil Change .....	34
● Spark plug .....	35
● Catalytic Converter.....	35
● Battery .....	36
● Throttle Cable Adjustment .....	39
● Clutch Adjustment .....	40
● Chain Adjustment .....	40



## CONTENTS

● Brake .....	42
● Maintenance of Air Filter.....	44
● Bulb Replacement .....	44
● Fuse Replacement .....	45
● Lubrication points .....	46
● Adjustment of Valve Clearance .....	46
● Tire .....	47
Storage Guideline .....	48
Specification & Technical Parameter .....	50



**Benelli**

TRK 502/ 502X

PURE PASSION SINCE 1911 

## SPECIAL REMINDING

Warning: The motorcycle must be equipped with the qualified fuse for a safe driving, any other unqualified specifications of fuses are not allowed to use, especially the electric wires which would result severe damages to other parts, even fire accidents.

Location of fuse: beside the battery.

Burnt fuse is usually caused by the internal circuit fault of the motorcycle. Simply estimate the whole situation of the motorcycle before changing the spare fuse and if the fuse still burn after changing, send the motorcycle to the maintenance service center as soon as possible. It can only be driven after the fault is resolved.

Notes:

Before changing the fuse, switch the key to "  " in case of short circuit;

\* Make sure the contact point of fuse is not broken while changing the fuse, which would result bad contact, parts damage, and even fire.

No reconfiguration: Do not reconfigure the motorcycle or change the places of the parts and accessories at will, which would have a strong impact on the stability and safety of the motorcycle, probably operation faults. All the reconfigurations of the electric system, emission control system, canister and any other systems or parts are against the driving safety and other relative traffic administration regulations. And all the quality problems and consequences resulted by the user's reconfiguration or changing of the parts without authorizations would be taken by the user himself. The user shall obey the specific regulations and rules of the traffic administrative department.



### Notes

Running in of Motorcycle

The very beginning 1,000km driving-way of the motorcycle is the most important part of its service life. If the running in is carried normally, a longest service life can be assured and the performances of the new motorcycle can be fully fulfilled.

## PREFACE

Thanks for choosing Benelli motorcycle, which is combined with international advanced technologies and would bring you happy and safe driving experience.

Please fully understand the rules and requirements stated in this manual.

This instruction manual covers the maintenance procedures, which would ensure the maximum performances and highest durability of your motorcycle if appropriately operated.

Our company is equipped with professional technical maintenance personnel and department, which is able to provide you with high quality technical maintenance services. We make great efforts to develop the products quality and performances so that the appearances and structures can be improved and may have difference than the data in this manual. The picture information here is only for reference, subject to our products.



**Benelli**

TRK 502/ 502X

PURE PASSION SINCE 1911 

## SAFETY NOTES

Please carefully read this manual and stand by the key rules. The words of "Alarm", "Caution" and "Note" are used here to indicate the importance degrees, please make sure that you have fully understand the meanings as following:

**Alarm**----- This is for the important procedures that may endanger safety of the driver and would bring injuries if ignored.

**Caution**----- This is for the relative operation specifications of the motorcycle in case of damages to the motorcycle.

**Note**----- This is for the maintenance

This instruction manual is a daily care issues document of this motorcycle, which should be together transferred to a second owner if this motorcycle is to be transferred.

## SAFETY NOTES

### **Alarm:**

For the safety purpose, the driver should be specifically careful with understanding on the safety notes before driving.



## SAFETY NOTES

1. Have a complete inspection before starting the engine so as to prevent possible accidents or damages of parts.
2. Many accidents happen due to inexperienced driver. Make sure the driver is qualified before driving the motorcycle. Never give it to any people without a driving license.
3. Most of the crashes between cars and motorcycles are caused by the car drivers' "not seeing" the motorcycle drivers. In order to avoid accidents, the driver shall expose himself/herself by:
  - Wearing bright colored and reflective clothes;
  - Don't drive into the invisible corner of rear-view mirror of the other car drivers.
4. The driver shall obey the national and local laws and rules.
  - Speeding is one of the key reasons of the accidents. So keep the speed in the limit stated.
  - Use signals lights before turning or braking/accelerating to prevent accidents
5. In the driving, the driver should hold the handles and keep both feet on the pedals and the passenger should grab somewhere on the vehicle or the driver with feet on the passenger pedals.
6. Any reconfiguration or disassembly of the parts is illegal, which would affect the safety driving and maintenance.
7. The after-market accessories shall not affect the safety driving and operation performances of the motorcycle. Overloading of the electrical systems would result dangers to the vehicle.
8. Do not operate the engine within confined space as the exhaust gas would cause damage to the body.



**Benelli**

TRK 502/ 502X

PURE PASSION SINCE 1911 



### PROTECTION CLOTHES

1. Fatal accidents of motorcycle drivers are mostly caused by head injuries. For the purpose of personal safety, the driver should wear a safety helmet, and also motorcycle boots, gloves and protection clothes. The passenger shall also wear the same.
2. The exhaust pipe will be very hot during driving and the heat will last after turning off the engine. Never touch the muffler and wear those clothes that can totally cover the legs.
3. Don't wear those loose clothes that may interfere with the control levers, pedals or wheels.

**Caution:**

This model is only designed to drive on road.



## SERIAL NUMBER

Vehicle identification number (VIN) and the serial number are used for the registration of the motorcycle, which can also make sure that the dealer would provide you better services involving accessories purchasing or other services.

Record the numbers for the possible use in the future.

Vehicle identification number (VIN) is printed on the right side of the head tube.

The engine number is printed on lower part of the right case of engine crank case

Please write down the numbers for your reference.

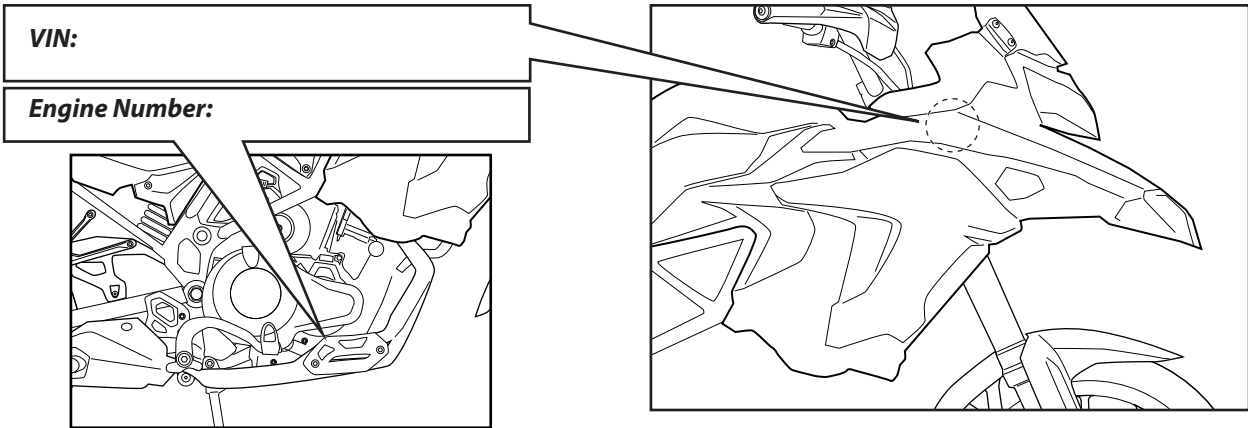

**Benelli**

TRK 502/ 502X

PURE PASSION SINCE 1911 

## LOCATION OF PARTS

### On-Road Version

Left view

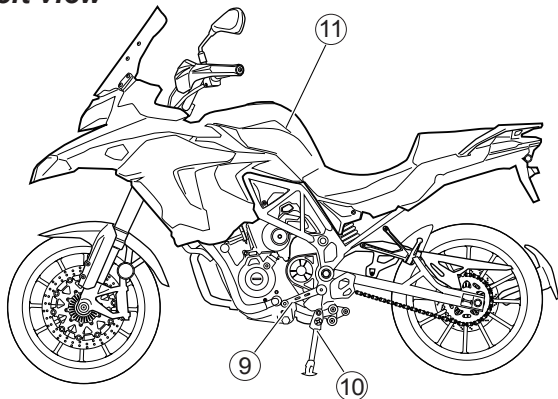

- |                       |                       |
|-----------------------|-----------------------|
| ① Clutch lever        | ⑦ Rear shock absorber |
| ② Left handle switch  | ⑧ Rear brake pedal    |
| ③ Meter               | ⑨ Shift pedal         |
| ④ Right handle switch | ⑩ Side stand          |
| ⑤ Throttle grip       | ⑪ Tank                |
| ⑥ Front brake lever   |                       |

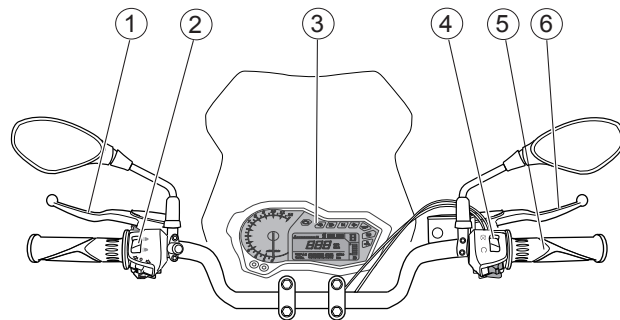

Right view

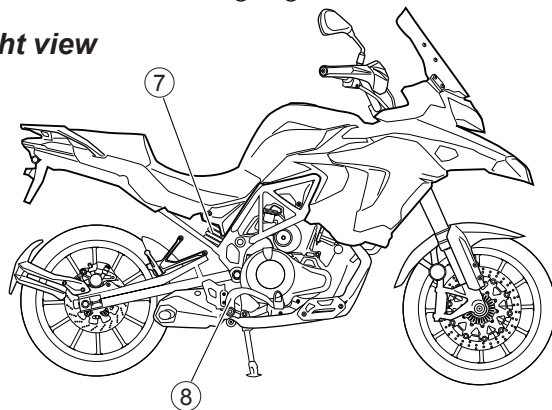

## LOCATION OF PARTS

### Off-Road Version

#### Left view

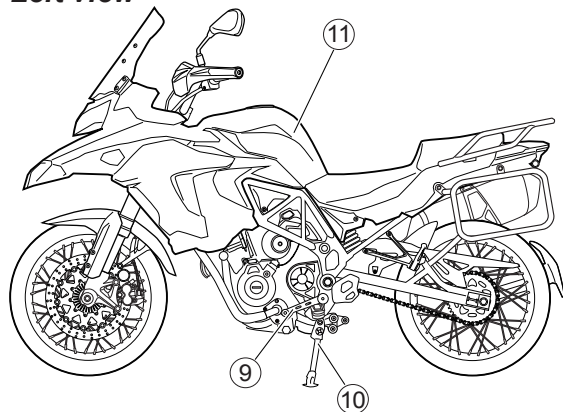

- |                       |                       |
|-----------------------|-----------------------|
| ① Clutch lever        | ⑦ Rear shock absorber |
| ② Left handle switch  | ⑧ Rear brake pedal    |
| ③ Meter               | ⑨ Shift pedal         |
| ④ Right handle switch | ⑩ Side stand          |
| ⑤ Throttle grip       | ⑪ Tank                |
| ⑥ Front brake lever   |                       |

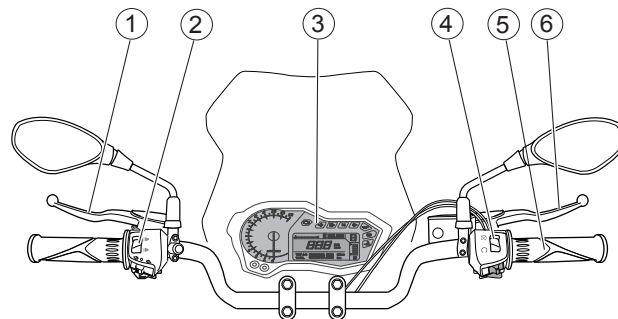

#### Right view

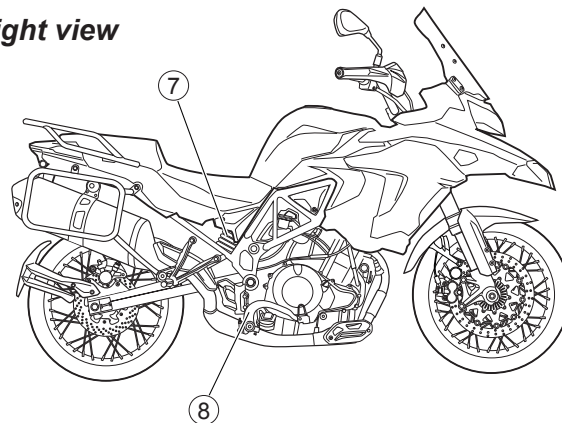

**Benelli**

TRK 502/ 502X

PURE PASSION SINCE 1911 

## LOCATION OF PARTS

### Meter & Indicator

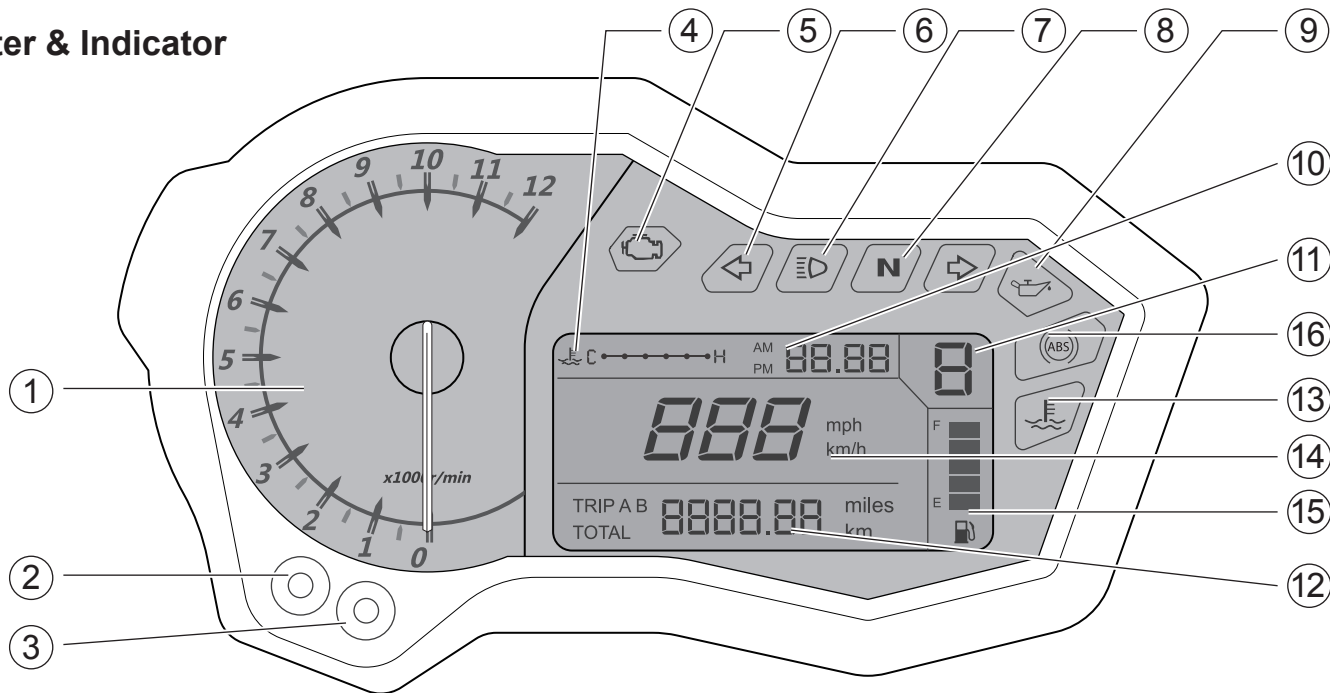

### 1. TACHOMETER

Tachometer indicates the revolution per minute of engine.

### 2. ADJUST BUTTON

Short press the button to switch between km/h and mph. Long press the button to reset the "Trip" mileage.

### 3. SELECT BUTTON

Short press the button to switch between trip and odometer functions on the meter. Press button "SELECT" for several seconds, there will appear the interface for time adjustment: "SELECT" for selection of digits of time display and "ADJUST" for adjustment of each value.

### 4. WATER TEMPERATURE INDICATOR

This indicator indicates the temperature of cooling liquid. When the pointer is in between C and H, the temperature is normal. It should stop to check the water tank if the pointer is higher than H level.

### 5. ENGINE CONTROL SYSTEM TROUBLE INDICATOR

Return to authorized dealer if this indicator is activated during riding.

### 6. TURNING INDICATOR

The indication lamps would flash with the turning signals.

### 7. HIGH BEAM INDICATOR LAMP

When the high beam lamp of the headlamp turns on, the high beam indicator lamp would be on.

### 8. NEUTRAL INDICATOR LAMP

When the transmission is in the neutral, the indicator lamp would be on.

### 9. ENGINE OIL PRESSURE WARNING LAMP

When this indicator light up, that means the bike has the risk of insufficient lubrication and should be checked/ repaired immediately.

### 10. CLOCK

It shows the time.

### 11. GEAR INDICATOR LAMP

Numbers on the meter indicate the gear positions of the vehicle including 1, 2, 3, 4, 5, and 6.

### 12. ODOMETER & TRIP METER

Relative mileage (TRIP): it records the mileage the vehicle covers in a period of time. Odometer (TOTAL): it records the total mileage the vehicle has covered in km.



### 13. WATER TEMPERATURE INDICATOR

It should stop to check the water tank if the INDICATOR is light .

### 14.SPEEDOMETER

Speedometer shows the running speed, hours/kilometers.

### 15. FUEL LEVEL INDICATOR

It indicates the fuel level in the fuel tank.

### 16. ABS INDICATOR LIGHT

1. ABS failure -- If any type of ABS failure is detected and stored, ABS indicator light is lit and stays on after repaired, then ABS indicator light will be unlit after the next Power switch ON/OFF and when vehicle speed exceeds 5km/h.
2. ABS is under OFF mode --ABS indicator light Blink 1 time/1.27s (Slow Blink)
3. When press the the ABS switch within 3s ~30s --ABS indicator light Blink 1 time/0.32s(Quick Blink)
4. ABS is under ON mode -- When keyswitch turned on, the ABS indicator lamp lit and stays activated, until the motorcycle drive off, reaching about 3~5KM/H will the ABS indicator lamp be unlit.

Normally the ABS indicator light comes on when the ignition switch is turned on and goes off shortly after the vehicle starts moving. If the indicator light shows any of the following, a fault or faults may have occurred in the ABS. You should have the vehicle checked by an authorized Benelli dealer.





- a. The light does not come on when the ignition switch is turned on.
- b. The light remains lit after the vehicle moving over 5km/h.

Remember that the ABS does not function when the indicator light is on, but if only the ABS system fails (without any other malfunctions in mechanical parts, for example, brake hoses, master cylinders, brake calipers), the conventional brake system should still work normally.



## PRIMARY PARTS

### KEY SWITCH



- “” (On) position: The circuits are on
- “” Position: turn left to the maximum, press the key to the position of “”. Take out the key. In this condition, the vehicle has been locked. If you want to unlock the vehicle, insert the key and turn clockwise.
- “” (Off) position: All the circuits are off.

### LEFT HANDLE

#### 1. HORN BUTTON

Press down on the button, to activate the horn.

#### 2. HIGH & LOW BEAM SWITCH

Turn the switch to “” position, the high beam of headlamp turn on and the indicator lamp on the meter would also turn on; turn the switch to “” position, the low beam of headlamp turn on.

#### 3. DIRECTION INDICATOR LAMP SWITCH

Turn the switch to “” position, the left direction signal lamp flashes; turn the switch to “” position, the right direction signal lamp flashes. And the indicator lamps would turn on accordingly.

#### 4. PASSING SWITCH

When passing other vehicles, press this button so the high beams of the headlamp would flash to alarm the vehicles in front of you.

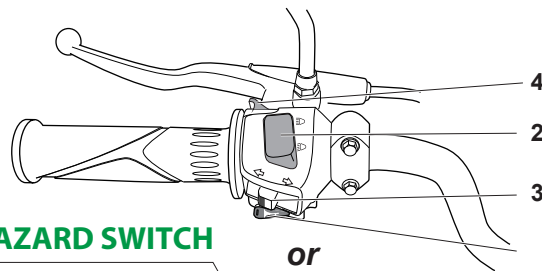
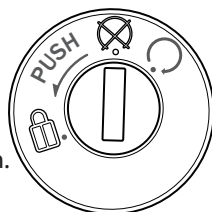

### HAZARD SWITCH

or

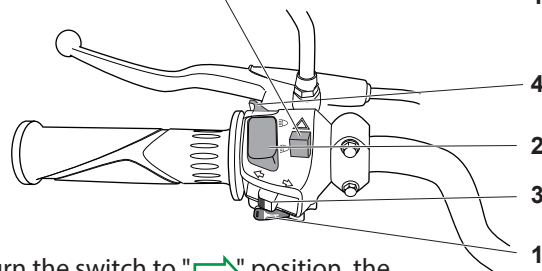

**Benelli**

TRK 502/ 502X

PURE PASSION SINCE 1911 



**Alarm :**

Turn on the direction signal lamps in time when changing the driveway or turning a direction and turn off the lamps.

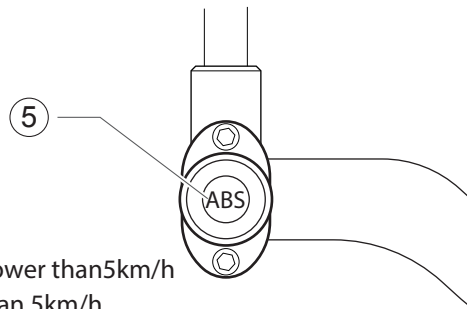

**5. ABS SWITCH**

If you want to enable/disable the ABS , please keep you motorcycle slower than 5km/h or stop, because the ABS switch only works when vehicle speed is lower than 5km/h.

From ABS ON mode → OFF mode

Please Keep pressing the ABS switch precisely within the range of 3~5 seconds, the ABS indicator light should be changed from lit to blink as per 1.27s (Slow Blink) when you release the switch, Now the ABS was turned OFF and the brake will work as conventional system.

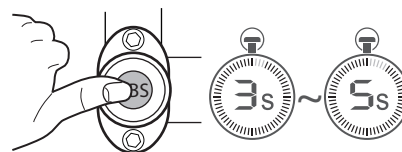

From ABS OFF mode → ON mode

Please keep pressing the ABS switch precisely within the range of 3~5 seconds, the ABS indicator light should be changed from blink as per 1.27s (Slow Blink) to constant lit when you release the switch.

Or you can turn the power switch off and on to reset the ABS system to On mode

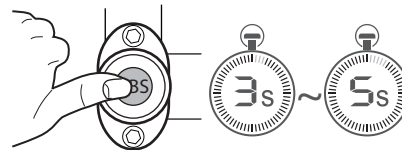

## PRIMARY PARTS

The operation will be ignored by the system if you keep pressing the ABS switch within 5s~30s. ABS will keep the current mode.

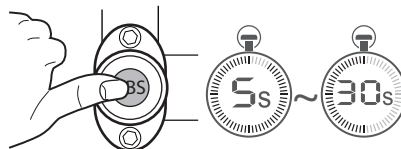

The ABS will be changed to ON mode from any other mode if the switch was stuck or pressed more than 30s.

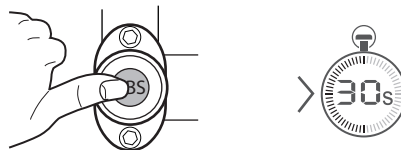

### NOTICE

The ABS switch does not work if you press the ABS switch as whichever of the front and rear wheel speed is over 5km/h.

## Anti-lock Brake System (ABS) for models equipped with ABS

ABS is designed to help prevent the wheels from locking up when the brakes are applied hard while running straight. The ABS automatically regulates brake force intermittently, gaining gripping force and braking force helps prevent wheel lock-up and allows stable steering control while stopping. Brake control function is identical to that of a conventional vehicle. The brake lever is used for the front brake and the brake pedal for the rear brake.

Although the ABS provides stability while stopping by preventing wheel lock-up, remember the following characteristics:



**Benelli**

TRK 502/ 502X

PURE PASSION SINCE 1911 

- To apply the brake effectively, use the front brake lever and rear brake pedal simultaneously in the same manner as conventional vehicle brake system.
- ABS cannot compensate for adverse road conditions, misjudgment or improper application of brakes. You must take the same care as with vehicles not equipped with ABS.
- ABS is not designed to shorten the braking distance. On unpaved, uneven, or downhill surfaces, the stopping distance of a vehicle with ABS may be longer than that of an equivalent vehicle without ABS. Use special caution in such areas.
- ABS will help prevent wheel lock-up when braking in a straight line, but it cannot control wheel slip which may be caused by braking during cornering. When leaning in corners, it is better to limit braking to gentle application of both brakes or not to brake at all. Reduce your speed before you enter the corner. Same as conventional brake system, an excessive sudden braking may cause wheel lock up and lose control.
- During braking, ABS will not prevent the rear wheel from lifting.



### **WARNING**

ABS cannot protect the rider from all possible hazards and is not a substitute for safe riding practices. Be aware of how the ABS operates and its limitations. It is the rider's responsibility to ride at appropriate speeds and manner for weather, road surface and traffic conditions.



## PRIMARY PARTS

The computers integrated in the ABS compare vehicle speed with wheel speed. Since non-recommended tires can affect wheel speed, they may confuse the computers, which can extend braking distance.



### **WARNING**

Use of non-recommended tires may cause malfunctioning of ABS and can lead to extended braking distance. The rider could have an accident as a result. Always use recommended standard tires for this vehicle.



### **NOTICE**

- ABS indicator light may come on under certain extreme riding condition. For example, wheelie, stoppie, or burn-out, rear-wheel drifting, or any maneuvers may cause the front and rear wheel to have different rotation status. In this case, first turn the ignition key to “OFF” , and then back to “ON” . ABS indicator light goes off by this operation, but if ABS indicator light remains lit after the vehicle runs at the speed of approximately 5 km/h or above, you should have the bike checked by an authorized Benelli dealer.
- When the ABS is functioning, you may feel a pulsing in the brake lever or pedal. This is normal. You don’ t need and should not stop applying brakes when this specific pulsing feeling appears.
- ABS does not function at speeds of approximate 5 km/h or below.
- ABS does not function if the battery is discharged.



**Benelli**

PURE PASSION SINCE 1911 

TRK 502/ 502X

## PRIMARY PARTS

### RIGHT HANDLE

#### 1. ENGINE STOP SWITCH

When the switch is on "○" position and the power is on, the engine runs.

When the switch is on "⊗" position and the power is off, the engine will not run.

**Note:** Under normal conditions, this switch shall be on "Operate" (○) position. Use this switch under emergency situation, for example accident or key switch problems.

#### 2. HAZARD SWITCH "△"

Turn to "△" and the four direction signal lamps would flash to warn for emergency situation; turn to "●" for daytime driving.

#### 3. ELECTRIC STARTER BUTTON

Pull the clutch lever or put in Neutral gear and press the button to run the electric motor and start the engine.

#### 4. LIGHT SWITCH

Pull the clutch lever or put in Neutral gear and press the button to run the electric motor and start the engine.

Turn switch to position of "☀" to light up the front lamp; Turn to "☾☽" to light up meter lamp, city light and tail lamp; turn to "●" for daytime driving.

Without Headlight Switch

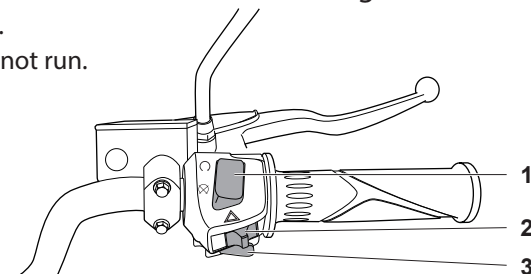

or

With Headlight Switch

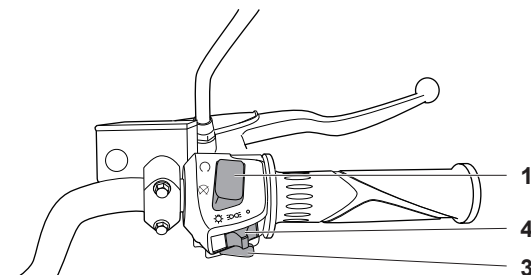

**Benelli**

TRK 502/ 502X

PURE PASSION SINCE 1911 

### FUEL TANK

The capacity of fuel tank (including reserve) is about 20L.

To open fuel tank cap, please insert the key and turn it clockwise and open the cover. To close the fuel tank, please recap and then press it. Take away the key when you hear the sound of locking.

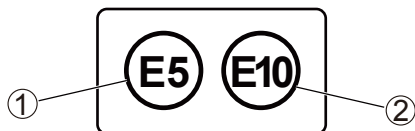

Use fuel identified by either of the above symbols.

1. Gasoline containing up to 5% ethanol by volume.
2. Gasoline containing up to 10% ethanol by volume.

#### **Alarm :**

Do not over fill the fuel tank. Do not make fuel splashes on hot engine.

Please stop the engine and turn the ignition key to "  " (Off) position when you need to refuel.

Do not forget to lock the fuel tank cover after adding the fuel in case of evaporation to the air, which is waste of energy and would pollute the environment. Don't use fire when refueling.



## PRIMARY PARTS

### REAR SHOCK ABSORBER

The motorcycle is equipped with one rear shock absorber on the right side of bike.

Spring pre-load adjustment.

The rear shock absorber is equipped with adjustment ring nuts for preload adjustment.

Adjust the spring preload as follows:

To increase the preload setting of the spring, turn the adjustment ring nut with special wrench as illustrated, to make the suspension stiffer.

Please rotate opposite direction to achieve a softer setting. After adjustment, please make sure the lock nut tightened to ensure safety of riding.

Rebound damping adjustment

The rear suspension rebound damping can be adjusted by the adjusting knob in the lower end of rear suspension. To adjust the rebound damping, please follow the procedure:

1. Turn the adjust knob as illustrated until feeling tight and no click sound heard, this is the zeroing point with maximum rebound damping effect (rebound extremely slow).

2. Turn the adjust knob in opposite direction, and count for clicking sound. The total adjustable range is 77clicks from the zero point, in normal riding, the setting should be 5~10 clicks according to the road condition and rider's preference.

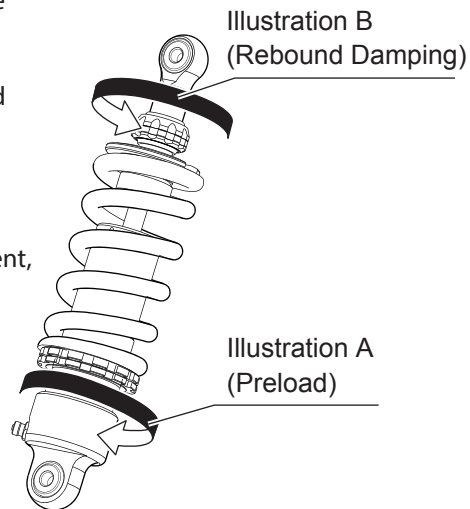

## PRIMARY PARTS

Generally speaking, when the spring preload is increased, the rebound damping should also be increased accordingly. If you are not sure how to adjust the rear suspension correctly, please refer to the authorized dealers for technical advice.

### **Alarm :**

Rotate this adjusting knob with hand only, and never use too much force, or the rear suspension will be damaged. This will be deemed as abnormal usage, will not be covered by warranty.

### **REAR BRAKE PEDAL**

Step the rear brake pedal to slow down the rear wheel. Brake light will turn on while rear brake is in use.

REAR BRAKE PEDAL

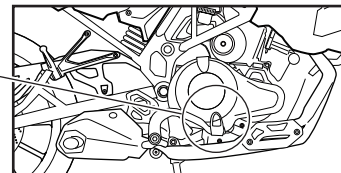

### **SHIFT PEDAL**

This motorcycle is equipped with six-speed constant mesh gearbox.

SHIFT PEDAL

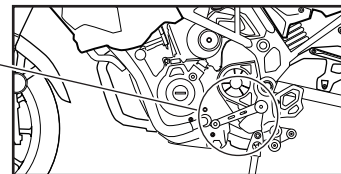

### **Caution:**

When the transmission is on neutral position, the indicator lamp would turn on. Slowly release the clutch lever to make sure the transmission is on the neutral position.



**Benelli**

TRK 502/ 502X

PURE PASSION SINCE 1911 



## NOTICE OF USE OF FUEL AND ENGINE OIL

Slow down the motorcycle when turning to the low gear. Revving up the engine slightly to shift gears in more smooth way to avoid damaging gears

### TOOL BAG

The tool bag is in the seat cushion. By using tools in the bag, you can do basic repair and adjustment and change some parts when needed.

## NOTICE OF USE OF FUEL AND ENGINE OIL

### Fuel

It is a must to use lead free gasoline. Use gasoline contains octane number more than 93.

Notice: Use lead free gasoline can extend the working life of spark plug.

### Engine Oil

Please use four-stroke engine oil it should be equal or higher than API SAE service grade SF. The specification is SJ10W/50.

Type Full synthetic oil SJ10W-50 or SN 15W-50 Capacity 2.9L±0.05L
---



For driving a new motorcycle in its first 1,000km way, the engine should not be over revved and all the gears shall not be over 80% of red zone engine rpm; don't operate the throttle under a fully open position; change the gears in time to keep the engine rpm in reasonable range. It is strongly suggested to use the motorcycle very carefully during its running in period; also the rider has to be familiar to the performance.

Note: In the first 300km of break in, you should examine the cleanliness of the engine oil frequently. Check the oil level of engine oil before driving.

### INSPECTION BEFORE DRIVING

Please check on the following contents which are very important before driving,

Content	Comments
Handlebar	1) Stable 2) Turn smoothly 3) No sliding or loose
Braking	1) Right clearance of the lever and brake pedal 2) No sponge feeling



## INSPECTION BEFORE DRIVING

Tire	<ol style="list-style-type: none"><li>1) Appropriate air pressure</li><li>2) Appropriate tire treads depth</li><li>3) No crack or cut</li></ol>
Fuel Level	Sufficient fuel for the driving
Light	Operate all the lamps – headlight, taillight, stoplight, instrument-panel light and city light.
Indicator Lamp	High beams indicator lamp, gear Indicator light, and turning indicator.
Horn & Brake Switch	Horn & Brake Switch
Engine Oil	Correct oil level
Throttle	<ol style="list-style-type: none"><li>1) Appropriate free play in clutch lever</li><li>2) Smooth operation</li></ol>
Clutch	<ol style="list-style-type: none"><li>1) Appropriate free play in throttle cable</li><li>2) Smooth operation, no stuck when returning to full close position</li></ol>
Driving Chain	<ol style="list-style-type: none"><li>1) Appropriate tightness</li><li>2) Appropriate lubrication</li></ol>



## **DRIVING TIPS**

### **HOW TO START THE ENGINE**

Insert the ignition key into the ignition lock and to "Ⓞ". Step on the shift pedal to the neutral. The neutral indicator light lightens up if the gear box is in neutral position. Start the engine by pushing the start switch.

#### **Caution:**

Do not run the engine in high speed when you do not drive the motorcycle, or it will become overheating and damage its inner parts.

#### **Warning:**

Do not start the engine indoor with bad ventilation or without ventilation. Do not leave a starting motorcycle when no one else is around.



**Benelli**

TRK 502/ 502X

PURE PASSION SINCE 1911 

### SMOOTH LAUNCHING

Hold the clutch lever, paused for an instant and step on the shift pedal to the first gear. Twist the throttle grip towards yourself and release the clutch lever slowly and smoothly at the same time. Then the motorcycle will begin to move forward smoothly.

**Warning:**

Put the stands back to retracted position before driving.

**Gear box usage**

Gear box can ensure a smooth running of engine within normal engine rpm Driver should choose a proper gear according to driving speed. It is dangerous to drive with clutch disengaged. Lower the gear when you slow down the motorcycle to make engine run within normal rpm range.

**Drive on slope way**

When drive on uphill road, motorcycle will slow down and seem to be lack of power. Switch to low gears so that engine can generate normal power. Shift the gear swiftly to prevent motorcycle from losing speed.

Turn to low speed gears in order to brake when driving on downhill slope.

Don't over rev the engine.

Brake usage and stopping



Twist the throttle grip in the direction away from yourself to close the throttle. Use front and rear brake evenly. Shift to low speed gear to slow down.

Before stopping the motorcycle, hold the clutch and shift to neutral position. Check the neutral position indicator light to check whether it is in neutral position.

**Notice:**

Inexperienced drivers usually use rear brake only, which will accelerate abrasion of the brake and result in longer stopping distance.

**Warning:**

It is dangerous only to use either the front brake or rear brake which may causes the motorcycle to skid or lose control. Be careful and use brakes properly when you drive on wet road or curved road.

The motorcycle should be parked on firm and flat road. If you have to park the motorcycle on a slope by the side stand, please shift to the first gear to prevent slipping. Shift to neutral position before starting the engine.

Turn the power key to the position "❌" to stop the engine.

Remove ignition key from the switch after locking for security reason.



### MAINTENANCE SCHEDULE

Listed below is the scheduled maintenance time table. Inspection, examination, lubrication and specified maintenance should be taken according to the following chart the inspection and maintenance of the key components, are required to be made by professionals. Better to consult authorized dealers to do inspection and maintenance for safety's sake.

### MAINTENANCE SCHEDULE:

I: Inspection, cleaning, adjustment, replacement

C: Cleaning R: Replacement

A: Adjustment L: Lubrication



## PRIMARY PARTS

NO	ITEM	ODOMETER READING					
		1000km	4000km	7000km	10000km	13000km	16000km
1	※ Fuel system						
2	※ Throttle Operation						
3	※ Air Filter		Per 6000km: I or R				
4	※ Spark Plug			R		R	
5	※ Valve Clearance	Per 24000km: I					
6	Engine Oil		Per 6000km: R				
7	※ Oil Filter		Per 6000km: R				
8	※ Fuel Injection						
9	Drive Chain	Per 1000km: I / L / A					
10	Battery						



**Benelli**

TRK 502/ 502X

PURE PASSION SINCE 1911 



## NOTICE OF USE OF FUEL AND ENGINE OIL

NO	ITEM	ODOMETER READING					
		1000km	4000km	7000km	10000km	13000km	16000km
11	Wear of Brake pads						
12	Brake System						
13	※ Braking Hydraulic						
14	※ Tube	Replace every two years					
15	※ Braking Hydraulic						
16	※ Fluid	Replace every two years					
17	Clutch						
18	Hanger Bracket						
19	※ Nut Bolt Fastener						
20	※ Wheel/Rim/Spoke						
21	※ Steering Bearing						
22	※ Cooling System						



※ Be repaired by authorized dealers: with qualified tools and inspection materials provided by the owner; by persons with mechanical repair certification; required to be followed the maintenance manual for self-inspection. Examination and repair are suggested to be taken by authorized dealers for the sake of safety, in cases of these items

### Notes:

1. Make more inspections for driving in dusty areas.
2. Repeat the shown regular inspection, if the odometer reading exceeds the fixed value.
3. Take more maintenance to keep good performance for frequent driving in heavy conditions as rugged roads.

### OIL LEVEL & OIL CHANGE

Check the oil level before starting the engine.

Put the motorcycle on side stand. Pull the handle bar and let the bike stand vertical to the flat ground. Check if the oil level is between the maximum and minimum level. If not, fill the qualified engine oil to the proper amount.

#### Oil Change & Oil Filter Replacing

1. Take down the oil filter with the special tool and oil drain bolt before oil draining.
2. Replace the oil filter with a new one if needed.

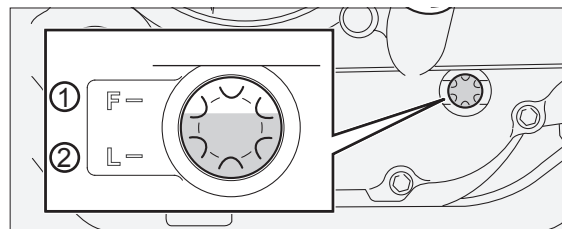

**Benelli**

TRK 502/ 502X

PURE PASSION SINCE 1911 

3. Install the oil filter with the special tool and oil drain bolt.
4. Fill the engine with qualified engine oil
5. Make the engine runs in idling for several minutes and turn off.
6. Make sure the oil reaches the upper limit mark without any oil leakage.

### SPARK PLUG

Clear away carbon deposit on the spark plug with small metal wire brush or spark plug cleaner during inspection period noted in the maintenance schedule. Readjust the electrode gap of spark plug with feeler gauge and keep the gap between 0.7~0.8mm.

Replace the sparking plug for each 6000km.

Type of Spark Plug: NGK CR8E

Do not Screw the spark plug too tight to avoid damaging the threads of cylinder cover.  
Don't let the foreign objects fall into the engine through spark plug hole during dismounting.

### CATALYTIC CONVERTER

In order to meet the requirements of environmental emission, the muffler of the motorcycle is equipped with catalytic converter.

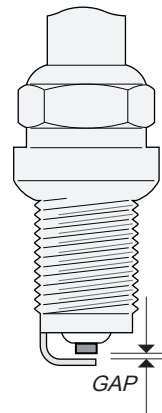

The catalytic converter contains precious metals as the catalyst, which will transform the hazardous substances in the exhaust gas, including carbon monoxide, hydrocarbon and nitrogen oxide into non-toxic carbon dioxide, water and nitrogen through chemical reaction.

Since the catalytic converter is very important, the defective catalytic converter will pollute the air and damage the performance of the engine, if the replacement is needed, please use the genuine parts or entrust the distributors to replace.

### **Caution:**

The catalytic converter is at high temperature area, please do not touch.

## **BATTERY**

Battery is under the seat cushion. The battery for the motorcycle is maintenance free type. For the new motorcycle, please ask the dealer of the company to fill electrolyte into the battery for you. It is not necessary to refill electrolyte in the future.

If you have to take out the battery for inspection, please follow these steps:

- a. Shut off power switch of the motorcycle;
- b. Remove the seat cushion;

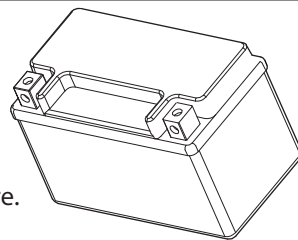

**12V8Ah (YTX9-BS)  
MF (Maintenance Free) Battery**



**Benelli**

TRK 502/ 502X

PURE PASSION SINCE 1911 

- d. Take down the negative terminal ( - ) first, and then the positive terminal ( + ) ;
  - e. Take out the battery gently.
- Install the battery in the reverse order of removal.

### **Attention :**

Connect correctly the battery wires when the battery is re-installed. The red wire shall be connected with the positive terminal ( + ) ; and black wire shall be connected to the negative terminal ( - ) . If the wires are wrongly connected, it may damage the electrical system and the battery.  
Power switch (key) shall be shut off while inspecting or replacing battery.

Please operate on the following requirements for the first use :

Remove the sealing paper on the battery. Inject specially supplied electrolyte into the battery and put on the battery sealing plug. Leave it for 30 minutes for full chemical reaction and then you can use the battery. For the new battery, initial charge after electrolyte filling will extend its service life. This operation shall be performed by your local dealers.

Connect the wire polarities correctly. Positive wire (red) shall be connected with the positive terminal ( + ) ; and negative wire (black) to the negative terminal ( - ) . Tighten terminal bolts. Clean frequently the erosive substances on the terminals with a wire brush while in use.

Please operate according to the following requirements while filling electrolyte into the maintenance-free battery:



- a. Place vertically the battery on a horizontal plane and remove the sealing tape.
- b. Take out the electrolyte from the plastic bag. Open its cover strip and use it as filling plug for the battery.

**Attention:** Please do not tear or puncture the sealing tape on the filling port.  
The cover strip can be kept as filling plug for the battery.

c. Lift the electrolyte container upside down vertically and align the six filling ports of the container with the six filling ports on the battery. Pull downward hard the electrolyte container so as to puncture the sealing tape on the filling ports of electrolyte container. Electrolyte thus flows from the container to the battery. Check the three filling pipes on both sides. At least there is one pipe that has bubbles coming out on each side, which means that electrolyte filling begins normally. Attention: Please be sure not to tilt the container, or electrolyte filling may be interrupted.

d. When you are sure that there is at least one pipe that has bubbles coming out on each side (three pipes on each side), leave it there and keep the filling process over 20minutes.  
If there is no pipe that has bubbles coming out on each side, tap slightly two to three times the bottom of the electrolyte container and check again if there is at least one pipe that has bubbles coming out on each side (The electrolyte cannot be taken down now).

e. When the electrolyte has completely flowed through, tap the container bottom several times to drain residual electrolyte; and then slowly pull out the electrolyte container.



f. The six sealing plugs on the cover strip align respectively to the six filling ports on the battery. Make sure the ends of the six sealing plug has inserted into the filling ports on the battery; press them hard into the ports till the cover strip makes a plane with the top surface of the upper part of the battery.

After completion of electrolyte filling, please do not pull out the cover strip or fill water, electrolyte or other liquid. Pay attention to the following matters while replacing the battery.

Before replacing the battery, please first determine the model of motorcycle and check if both batteries are of the same type. During motorcycle design, the battery specifications are considered as the best choice. If a battery of a different model is used, it may affect performance and life time of the motorcycle, and possibly causes electrical failure.

If the motorcycle will not be used for a long time, please remove the battery and charge it once a month.

**Warning:** Battery will produce explosive gases when chemical reaction occurs in the battery.  
Keep the battery away from fire, spark and high temperature places.  
The battery is filled with sulfuric acid (electrolyte). Electrolyte is poisonous substance.  
Please keep it out of reach of children.

### THROTTLE CABLE ADJUSTMENT

1. Screw off the lock nut.
2. Turn the adjustor to make the cable clearance within 10-20mm.
3. Retighten the lock nut after adjustment of cable clearance.



### CLUTCH ADJUSTMENT

The free play of clutch is measured from the free status of the lever, to the engagement point of the clutch the standard should be 10-20mm. Adjust in following methods, if anything abnormal.

- (1) Loose the locknut.
- (2) Screw in or out adjusting bolt and adjusting screw to make required free play.
- (3) Tighten locknut

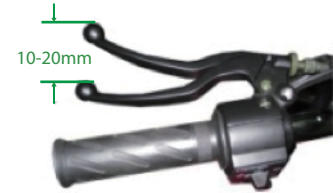

### CHAIN ADJUSTMENT

Adjust the tightness of drive chain for driving each 1000km's in following methods to reach the free play of 10~20mm. Make regular adjustment of the chain according to your driving condition.

**Warning:** Suggestions here are for regular maintenance schedule it's recommended for inspection and adjustment of the chain before each driving. Accident as chain detaching or serious damage on engine can be caused by excessively slack chain.



**Benelli**

TRK 502/ 502X

PURE PASSION SINCE 1911 



Adjust the chain in following methods:

1. Support the motorcycle with side stand.
2. Loosen rear axle nut.
3. Loosen locknut.
4. Turn adjusting nut to adjust the tightness of the chain. Reference marks are adopted on left and right swing arm and should reach the same grid after adjustment. Retighten the rear axle nut after adjust the chain tightness to 10~20mm and confirm again

### **Notice:**

When use new chain, check both front and rear sprockets if they are still in service limit and replace them, if necessary

During regular maintenance, check the following conditions of the chain:

- |                         |                             |
|-------------------------|-----------------------------|
| (1) Loose pin           | (2) Damaged roller          |
| (3) Rusty chain link    | (4) Twisted or snarled link |
| (5) Excessive free play | (6) Loose chain             |

The sprocket is probably damaged, if any above-mentioned problems on the chain are found.

Check the following items for sprocket:



(1) Over worn sprocket tooth (2) Broken or damaged sprocket tooth (3) Loosened sprocket fixing nuts

### **BRAKE**

The motorcycle uses disc brake as both the front brake and the rear brake. Adjustment is finished before delivery. Contact dealer if any problem.

#### Brake Fluid

The motorcycle uses DOT4 brake fluid. Please replace it every two years.

#### **Warning :**

In case of drinking the brake fluid by mistake or contacting with eye or skin, wash with a large amount of water, and seek medical advice immediately if in a serious condition.

Don't forget to check the amount level in the front brake fluid reservoir. Add appropriate brake fluid if necessary.

#### Brake pads

Check the front and rear wheel brake pads whether have been worn to limits. Change the pads if over the limit.



**Benelli**

TRK 502/ 502X

PURE PASSION SINCE 1911 

**Warning :**

Maintenance of braking system or brake pads should be taken by the authorized dealer which is equipped with necessary tools and can assure the quality of the service.

**Caution:**

The disk braking system has high pressure in the pipe require periodical maintenance in the manual.

Check the braking system everyday as follows:

1. Whether leak on the front and rear wheel braking system;
2. Whether leak, crack on the brake fluid tubes;
3. Check the feedback feeling on brake lever
4. Check abrasion condition of the front and rear wheel brake pads

Rear Brake

To adjust the stroke of rear brake pedal, screw or turn the adjusting bolt of rear brake, the free play be adjusted to 20~30mm.



### MAINTENANCE OF AIR FILTER

Air filter should be regularly maintained, especially when driving in areas full of dust and sand.

1. Dismount the seat, fuel tank and the side cover.
2. Remove the screw, open the cover of air filter and take out the filter element.
3. Immerse the filter element in clean solution and take out after cleaning for complete drying.
4. Immerse the filter element in clean engine oil again, after saturation, take out and squeeze off excessive oil.
5. Install the components back in the reverse order of dismount.

#### **Caution :**

Those highly flammable liquid like gasoline and organic solvent cannot be used for cleaning the filter element.

### BULB REPLACEMENT

Replacing of Head Lamp Bulb

Take off the cover, replace the old bulb with the same specification one, and finally set up in the reversed orders.



**Benelli**

TRK 502/ 502X

PURE PASSION SINCE 1911 

**Notice:**

The new bulb installed must in the same specification with the old one. High-power bulb will increase load to circuit system which will cause faults such like battery power shortage.

**FUSE REPLACEMENT**

The fuse is beside the battery. Frequent blowing of fuse indicates short circuit or over loading. Contact with the authorized dealer for proper repairing. Use the fuses for the same specification as indicated.

**Warning:**

It's dangerous to use other specifications of fuse, which would result severe failures like burning, firing.

Without Headlight Switch

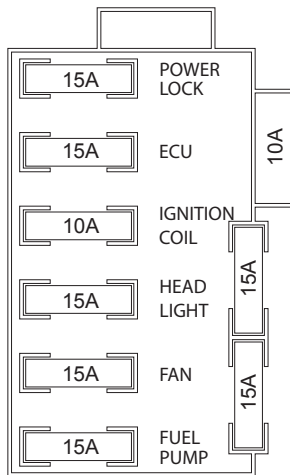

OR

With Headlight Switch

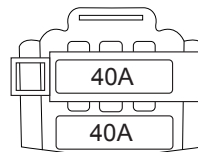
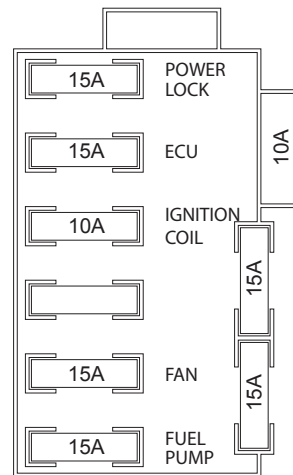

ABS fuse



### LUBRICATION POINTS

Appropriate lubrication is important to keep every part of your motorcycle in normal running and lengthen its working life and to ensure safe driving. Lubricate your motorcycle after you have driven it for a long mileage or the vehicle is wet due to raining or washing. Detail lubrication points are shown in the figure below:

Motorcycle lubricant

Lubricant grease

1. Rear brake pedal shaft
2. Side stand and its spring
3. Throttle cable
4. Pivot of front brake lever
5. Pivot of clutch lever

### ADJUSTMENT OF VALVE CLEARANCE

Check and adjust the valve clearance when the engine is cold.

The Standard Valve Clearance: Intake Valve: 0.15-0.19mm, Exhaust Valve: 0.20-0.25mm



**Benelli**

TRK 502/ 502X

PURE PASSION SINCE 1911 

### Notice:

Adjustment of valve clearance will have direct influence on the performance of engine, thus requiring strict accordance with the time interval required in "Maintenance Schedule". Adjustment should be done with professional technicians corresponding tools. In order to keep the valve clearance in good condition, we strongly recommend you to leave it up to consult to authorized dealers about this maintenance.

### TIRE

Inflation pressure and tire tread should be regularly checked. In order to ensure maximum safety and longer service life, inflation pressure requires more frequent routine check.

#### Tire Pressure

Insufficient tire pressure will not only accelerate wearing, but also have bad impact on driving stability such as making turning difficult. However, too high pressure will reduce the contact area between tire and ground, thus causing slipping or even getting out of control. Tire pressure should be kept in the standard range. Adjust the tire pressure under a "cold" condition.

<b>Front Wheel</b>	220kpa
<b>Rear Wheel</b>	250kpa

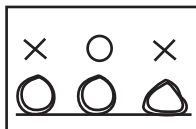

## STORAGE GUIDELINE

### Tire Tread

Driving a motorcycle with wheels excessively worn will reduce driving stability or even get out of control. When the tire tread of front wheel is less than 1.6mm, and the rear wheel's tread is less than 2mm or even less, replacement is strongly recommended.

## STORAGE GUIDELINE

### Storage

If you need to keep your motorcycle for a long time without using, it's suggested to following these instructions:

1. Change engine oil.
2. Lubricate drive chain
3. Detach the spark plug and add one teaspoon of (15~20cm<sup>3</sup>) clean engine oil to cylinder. Pushing the starting switch for several times to distribute oil in the cylinder, and install the spark plug again.
4. Remove the battery. Keep the battery in proper place which can avoid freezing and the direct sunlight.
5. Clean and dry the motorcycle. Wax the surface of the paint.
6. Inflate tire to the required pressure. Put the motorcycle on a block to make two tires off the ground.
7. Cover the motorcycle (no plastic or coating material) and keep it in the place with consistent temperature and low humidity. Do not keep your motorcycle under direct sunlight.



**Benelli**

TRK 502/ 502X

PURE PASSION SINCE 1911 



### Use the motorcycle after storage

1. Take off the cover and clean the motorcycle. Change engine oil if you keep your motorcycle for more than four months.
2. Install the battery and do charging as needed.
3. Wash away the anti-rust agent in fuel tank, and add new petrol into fuel tank.



## SIZE AND WEIGHT

Length.....	2200/2220mm
Width.....	915mm
Height.....	1450/1480mm
Wheelbase.....	1505mm
Dry Weight.....	213kg

## ENGINE

Type.....	2-cylinder/4-stroke/8-valve, water-cooled
Model.....	BJ269MR-A
Bore × Stroke.....	ø69x66.8mm
Displacement.....	500ml
Maximum Power.....	35KW/8500r/min
Maximum Torque.....	46N.m/6000r/min
Ignition System Type.....	TLI
Compression Ratio.....	11.5:1
Start Type.....	Electric Starting
Transmission System.....	Chain
Clutch.....	Wet multi-plate

Front Brake Type .....	disc brake
Rear Brake Type .....	disc brake
Front tire Specification.....	120/70ZR17M/C 110/80 R19
Rear tire Specification.....	160/60ZR17M/C 150/70 R17

## ELECTRICAL SYSTEM

Battery.....	12V 8Ah(YTX9-BS)
Magneto.....	Fly-wheel Magneto
Headlamp.....	12V 55/55W
Tail/Brake Lamp.....	LED 12V1.7/0.1W
Turn Signal Lamp.....	LED 12V 3.6W
Meter Lamp.....	12V 2W
Neutral Position Indicator Lamp.....	12V 2W
High beam indicator lamp.....	12V 2W
Turning indicator .....	12V 3W
Horn Specification.....	12V 3A

## CAPACITY

Fuel Tank (include reserve tank).....	20±0.5L
Fuel Type.....	93 & above



**Benelli**

TRK 502/ 502X

PURE PASSION SINCE 1911 



**Benelli**

[www.benelli.com](http://www.benelli.com)

**Benelli Q.J. S.r.l.**

Strada della Fornace Vecchia 3, 61122 Pesaro - Italy