 Details described or illustrated in this booklet may differ from the vehicle's actual specification as purchased, the accessories fitted or the national-market specification. No claims will be asserted as a result of such discrepancies.
Dimensions, weights, fuel consumption and performance data are quoted to the customary tolerances.
The right to modify designs, equipment and accessories is reserved. Errors and omissions excepted.



Benelli

TNT 135

Mar 12th 2019

INTRODUCTION

Welcome to the world of motorcycling!

As the owner, you are benefiting from the vast experience and newest technology regarding the design and manufacture of high-quality products, which have earned us a reputation for dependability.

Please take the time to read this manual thoroughly, so as to enjoy all advantages of your vehicle. The Owner's Manual does not only instruct you in how to operate, inspect and maintain your vehicle, but also in how to safeguard yourself and others from trouble and injury.

In addition, the many tips given in this manual will help keep your vehicle in the best possible condition. If you have any further questions, do not hesitate to contact our dealer.

Our team wishes you many safe and pleasant rides. So, remember to put safety first!

Our company continually seeks advance in product design and quality. Therefore, while this manual contains the most current product information available at the time of printing, there may be minor discrepancies between your vehicle and this manual. If there is any question concerning this manual, please consult our dealer.

WARNING

Please read this manual carefully and completely before operating this vehicle.

IMPORTANT MANUAL INFORMATION

This is the safety alert symbol. It is used to alert you to potential personal injury hazards. Obey all safety messages that follow this symbol to avoid possible injury or death.

WARNING

indicates a hazardous situation which, if not avoided, could result in death or serious injury.

NOTICE

indicates special precautions that must be taken to avoid damage to the vehicle or other property.

TIP

provides key information to make procedures easier or clearer.

INTRODUCTION	1	• Engine break-in	15
Safety information	3	• Parking	16
• Safe-riding	3	PERIODIC MAINTENANCE AND ADJUSTMENT	16
• Further safe-riding points	5	• Periodic maintenance chart	17
DESCRIPTION	6	• Checking the spark plug	19
• Left view	6	• Engine oil	19
• Right view	6	• Idle speed	21
• Controls and instruments	7	• Valve clearance	21
CONSUMER INFORMATION	7	• Air filter	21
• VIN and engine serial number	7	• Checking the throttle cable free play	22
INSTRUMENT AND CONTROL	7	• Checking the clutch free play	22
FUNCTIONS	7	• Checking the front brake lever and rear brake pedal free play	22
• Main switch/steering lock	7	• Check the drum limit	23
• Meter & Indicator	8	• Checking the brake pads	23
• Handlebar	9	• Brake fluid	23
• Fuel Tank	11	• Checking the battery	24
• Rear shock absorber	11	• Replacing the fuses and bulbs	25
• Rear brake pedal	12	TIRE	25
• Shift pedal	12	STORAGE	26
PRE-OPERATION CHECKS	13	• Storage	26
OPERATION AND IMPORTANT RIDING POINTS	14	SPECIFICATIONS	27
• Starting the engine	14	• Specification	27
• Acceleration and deceleration	15		
• Braking	15		

SAFETY INFORMATION

Be a Responsible Owner

As the vehicle's owner, you are responsible for the safe and proper operation of your vehicle.

The safe use and operation are dependent upon the use of proper riding techniques as well as the expertise of the operator. Every operator should know the following requirements before riding this vehicle.

He or she should:

- Obtain thorough instructions from a competent source on all aspects of vehicle operation.
- Observe the warnings and maintenance requirements in this Owner's Manual.
- Obtain qualified training in safe and proper riding techniques.
- Obtain professional technical service as indicated in this Owner's Manual and/or when made necessary by mechanical conditions.

Safe Riding

Perform the pre-operation checks each time you use the vehicle to make sure it is in safe operating condition. Failure to inspect or maintain the vehicle properly increases the possibility of an accident or equipment damage. See the page for a list of pre-operation checks.

- This vehicle is designed to carry the operator and a passenger.
- The failure of motorists to detect and recognize vehicles in traffic is the predominating cause of automobile/vehicle accidents. Many accidents have been caused by an automobile driver who did not see the vehicle. Making yourself prominent appears to be very effective in reducing the chance of this type of accident. Therefore:
 - Wear a brightly colored jacket.
 - Use extra caution when you are approaching and passing through intersections, since intersections are the most likely places for vehicle accidents to occur.
 - Ride where other motorists can see you. Avoid riding in another motorist's blind spot
 - Many accidents involve inexperienced operators. In fact, many operators who have been involved in accidents do not even have a current driver's license.
 - Make sure that you are qualified and that you only lend your vehicle to other qualified operators.
 - Know your skills and limits. Staying within your limits may help you to avoid an accident.
 - We recommend that you practice riding your vehicle where there is no traffic until you have become

thoroughly familiar with the vehicle and all of its controls.

- Many accidents have been caused by error of the vehicle operator. A typical error made by the operator is veering wide on a turn due to excessive speed or under- cornering (insufficient lean angle for the speed).
- Always obey the speed limit and never travel faster than legal speed limit.
- Always signal before turning or changing lanes. Make sure that other motorists can see you.
- The posture of the operator and passenger is important for proper control.
- The operator should keep both hands on the handlebar and both feet on the operator footrests during operation to maintain control of the vehicle.
- The passenger should always hold onto the operator, the seat strap or grab bar, if equipped, with both hands and keep both feet on the passenger footrests. Never carry a passenger unless he or she can firmly place both feet on the passenger footrests.
- Never ride under the influence of alcohol or other drugs.
- This vehicle is designed for on-road use only. It is not suitable for off-road use.

Protective apparel

The majority of fatalities from vehicle accidents are

the result of head injuries. The use of a safety helmet is the most critical factor in the prevention or reduction of head injuries.

- Always wear an approved helmet.
- Wear a face shield or goggles.

Wind in your unprotected eyes could contribute to an impairment of vision that could delay seeing a hazard.

- The use of a jacket, substantial shoes, trousers, gloves, etc., is effective in preventing or reducing abrasions or lacerations.
- Never wear loose-fitting clothes, otherwise they could catch on the control levers or wheels and cause injury or an accident.
- Always wear protective clothing that covers your legs, ankles, and feet. The engine or exhaust system become very hot during or after operation and can cause burns.

• A passenger should also observe the above precautions.

Avoid Carbon Monoxide Poisoning.

All engine exhaust contains carbonmonoxide, a deadly gas. Breathing carbon monoxide can cause headaches, dizziness, drowsiness, nausea confusion, and eventually death.

Carbon Monoxide is a colorless, odorless, tasteless gas which may be present even if you do not see

or smell any engine exhaust. Deadly levels of carbon monoxide can collect rapidly and you can quickly be overcome and unable to save yourself. Also, deadly levels of carbon monoxide can linger for hours or days in enclosed or poorly ventilated areas. If you experience any symptoms of carbon monoxide poisoning, leave the area immediately, get fresh air, and seek medical treatment.

- Do not run engine indoors. Even if you try to ventilate engine exhaust with fans or open windows and doors, carbon monoxide can rapidly reach dangerous levels.
- Do not run engine in poorly ventilated or partially enclosed areas such as barns, garages.
- Do not run engine outdoors where engine exhaust can be drawn into a building through openings such as windows and doors.

Further safe-riding points

- Be sure to signal clearly when making turns.
- Braking can be extremely difficult on a wet road. Avoid hard braking, because the vehicle could slide. Apply the brakes slowly when stopping on a wet surface.
- Slow down as you approach a corner or turn. Once you have completed a turn, accelerate slowly.
- Be careful when passing parked cars. A driver might not see you and open a door in your path.

- Railroad crossings, streetcar rails, iron plates on road construction sites, and manhole covers become extremely slippery when wet. Slow down and cross them with caution. Keep the vehicle upright, otherwise it could slide out.
- The brake pads could get wet when you wash the vehicle. After washing the vehicle, check the brakes before riding.
- Always wear a helmet, gloves, trousers (tapered around the cuff and ankle so they do not flap), and a bright colored jacket.
- Do not carry too much luggage on the vehicle. An overloaded vehicle is unstable. Use a strong cord to secure any luggage to the carrier (if equipped). A loose load will affect the stability of the vehicle and could divert your attention from the road.

DESCRIPTION

Left view

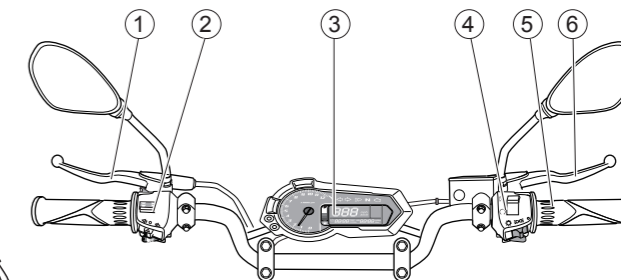
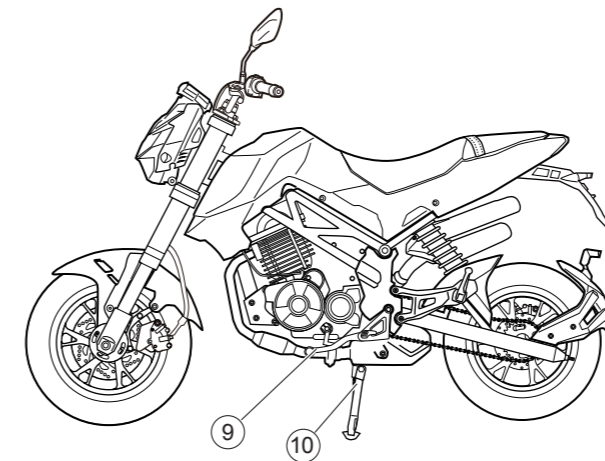

Right view

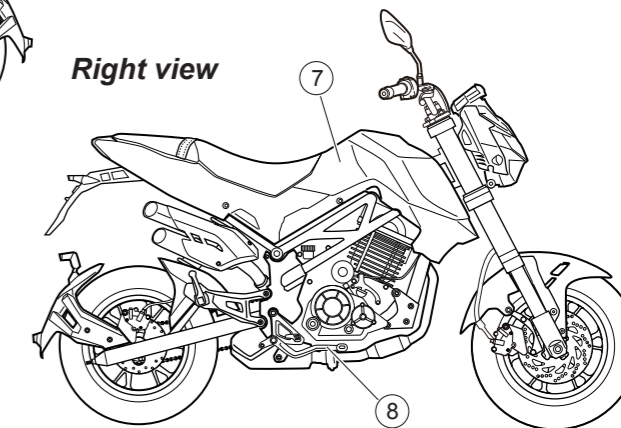

- | | |
|-----------------------|--------------------|
| ① Clutch lever | ⑦ Fuel tank |
| ② Left handle switch | ⑧ Rear brake pedal |
| ③ Meter | ⑨ Shift pedal |
| ④ Right handle switch | ⑩ Side stand |
| ⑤ Throttle grip | |
| ⑥ Front brake lever | |

CONSUMER INFORMATION

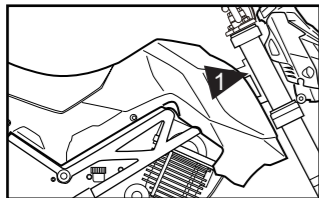

Vehicle identification number (VIN)

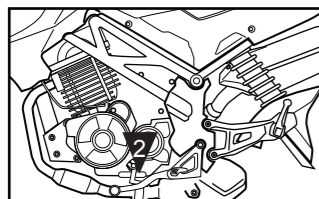

engine serial number

VIN No.
ENGINE No.

- The vehicle identification number ① is stamped on the right side steering head tube.
- The engine serial number ② is stamped on the lower left of the engine.

TIP

The vehicle identification number or the engine serial number are used to register the vehicle, they are also to assist your dealer in terms of ordering parts or referring to special service information

INSTRUMENT AND CONTROL FUNCTIONS

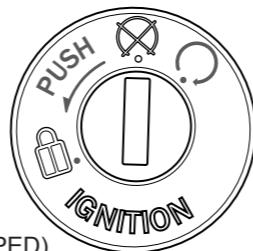

“⊗”(Off) position:
All the circuits are off.

“⊙”(On) position:
The circuits are on.

“P” (Parking): (IF EQUIPPED)
The taillight, license plate light and auxiliary lights are on. The hazard lights and turn signal lights can be turned on, but all other electrical systems are off. The key can be removed.

“🔒” (The steering lock) (IF EQUIPPED)
Turn the steering handle to left, press the key to “🔒” position, the steering lock is locked. When it needs to open, insert the key and turn to “⊗” position, the steering lock is released;

NOTICE

Do not turn your key to lock the vehicle while driving which is not necessary and is also apt to cause accident.
Press the key in a proper force.

Meter & Indicator

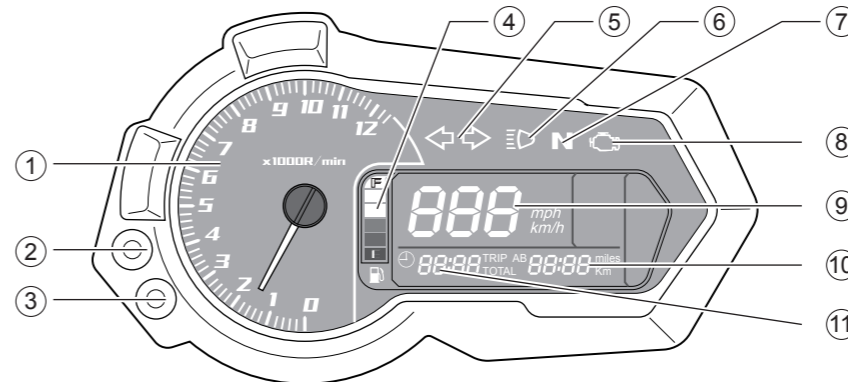

1. TACHOMETER

Tachometer indicates the revolution per minute of engine.

2. ADJUST BUTTON

Short press the button to switch between km/h and mph. Long press the button to reset the "Trip" mileage.

3. SELECT BUTTON

Short press the button to switch between trip and odometer functions on the meter. Press button "SELECT" for several seconds, there will appear the interface for time adjustment: "SELECT" for selection of digits of time display and "ADJUST" for adjustment of each value.

4. FUEL LEVEL INDICATOR

It indicates the fuel level in the fuel tank.

5. TURNING INDICATOR

The indication lamps would flash with the turning signals.

6. HIGH BEAM INDICATOR LAMP

When the high beam lamp of the headlamp turns on, the high beam indicator lamp would be on.

7. NEUTRAL INDICATOR LAMP

When the transmission is in the neutral, the indicator lamp would be on.

8. ENGINE CONTROL SYSTEM TROUBLE INDICATOR

Return to authorized dealer if this indicator is activated during riding.

9. SPEEDOMETER

Speedometer shows the running speed, kilometers/hour.

10. ODOMETER & TRIP METER

Relative mileage (TRIP): it records the mileage the vehicle covers in a period of time. Odometer (TOTAL): it records the total mileage the vehicle has covered in km.

11. CLOCK

It shows the time.

HANDLEBAR

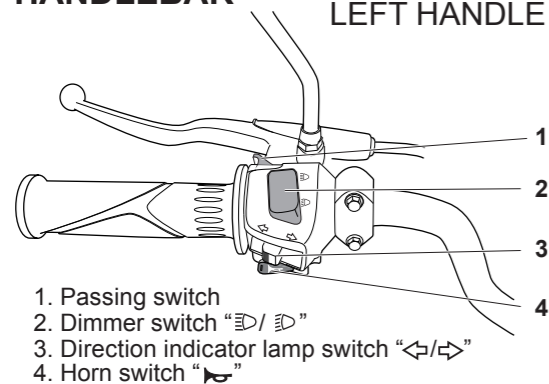

1. Passing switch
2. Dimmer switch “ / ”
3. Direction indicator lamp switch “ / ”
4. Horn switch “”

RIGHT HANDLE ALWAYS HEADLIGHTS ON (IF EQUIPPED)

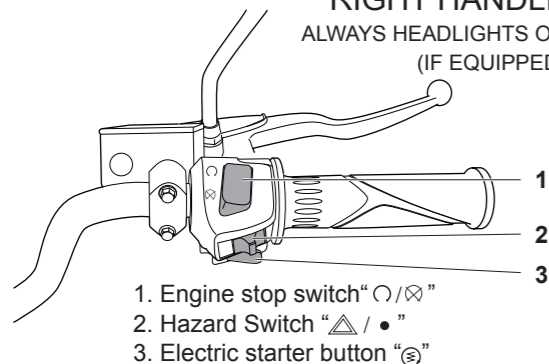

1. Engine stop switch “ / ”
2. Hazard Switch “ / ”
3. Electric starter button “”

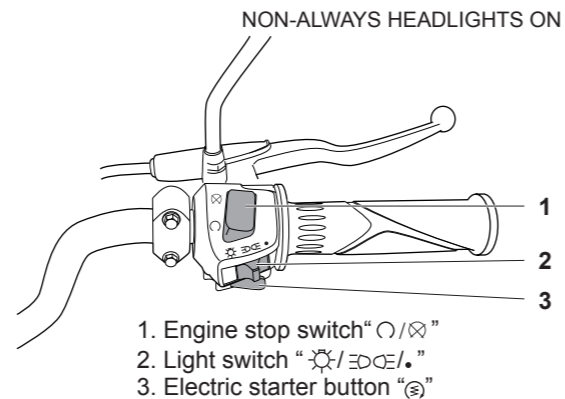

1. Engine stop switch “ / ”
2. Light switch “ / / / ”
3. Electric starter button “”

Dimmer switch

Turn the switch to “” position, the high beam of headlamp turn on and the indicator lamp on the meter would also turn on; turn the switch to “” position, the low beam of headlamp turn on.

Direction indicator lamp switch

Turn the switch to “” position, the left direction signal lamp flashes; turn the switch to “” position, the right direction signal lamp flashes. And the indicator lamps would turn on accordingly.

WARNING

Turn on the direction signal lamps in time when changing the driveway or turning a direction and turn off the lamps.

Passing switch (IF EQUIPPED)

When passing other vehicles, press this button so the high beams of the headlamp would flash to alarm the vehicles in front of you.

Horn button

Press down on the button, to activate the horn.

Engine stop switch

When the switch is on “” position and the power is on, the engine runs.

When the switch is on “” position and the power is off.

NOTICE

Under normal conditions, this switch shall be on “Operate” () position. Use this switch under emergency situation, for example accident or key switch problems.

Electric starter button

Pull the clutch lever or put in Neutral gear and press the button to run the electric motor and start the engine.

Clutch lever switch (IF EQUIPPED)

When starting the engine or shifting, pull the clutch lever to cut off driving on the rear wheel.

Front brake lever

Pull the brake lever properly to use the front brake.

Throttle grip

Throttle grip is to control the speed of engine. Twist the grip towards yourself when revving up or turn it in opposite way to slow down.

Light switch

Turn switch to position of “” to light up the front lamp; Turn to “” to light up meter lamp, city light and tail lamp.

Hazard Switch (IF EQUIPPED)

Turn to “” and the four direction signal lamps would flash to warn for emergency situation; turn to “” for daytime driving.

FUEL TANK

To open fuel tank cap, please insert the key and turn it clockwise and open the cover.

To close the fuel tank, please recap and then press it. Take away the key when you hear the sound of locking.

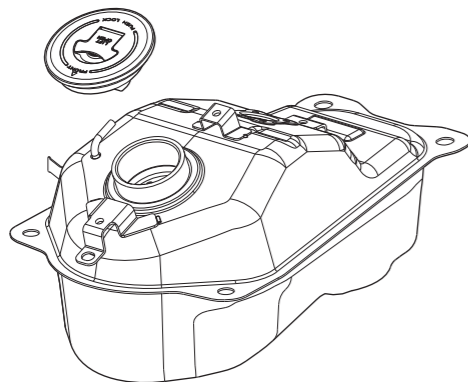

Recommended fuel:
REGULAR UNLEADED
GASOLINE ONLY
Fuel tank capacity:
7.2 L

WARNING

Do not over fill the fuel tank. Do not make fuel splashes on hot engine.

Please stop the engine and turn the ignition key to " ⓧ " (Off) position when you need to refuel. Do not forget to lock the fuel tank cover after adding the fuel in case of evaporation to the air, which is a waste of energy and would pollute the environment.

REAR SHOCK ABSORBER

Each shock absorber is equipped with a spring preload adjusting ring the spring of the rear wheel can be adjusted in compliance with the driver's weight and loading condition, driving method and road conditions. Adjust when vehicle it is stable on the main stand or side stand, turn the preload ring to the place required.

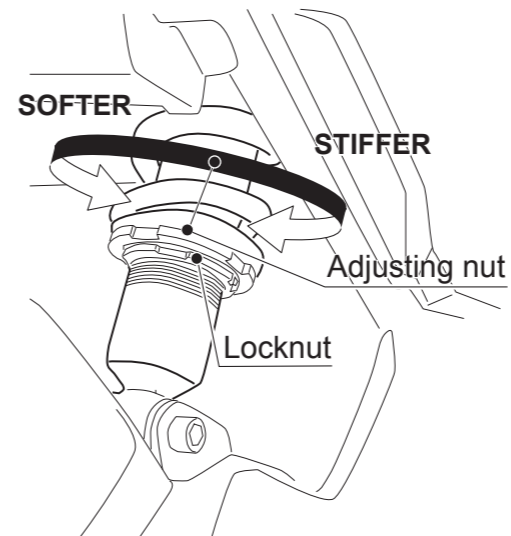

TORQUE VALUE

Upper fixing bolt: 37-44N.m

Lower fixing bolt: 22-29N.m

Adjustable

REAR BRAKE PEDAL

Step the rear brake pedal to brake the rear wheel. Brake light will turn on while rear brake is in use.

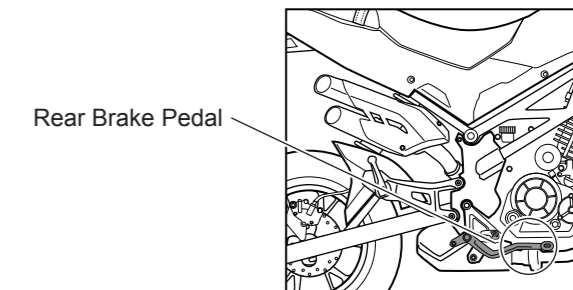

SHIFT PEDAL

Slow down the vehicle when turning to the low gear. Revving up the engine slightly to shift gears in more smooth way to avoid damaging gears.

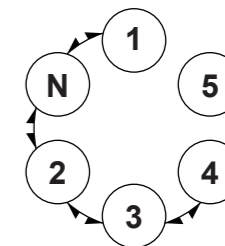

PRE-OPERATION CHECKS

Inspect your vehicle each time you use it to make sure the vehicle is in safe operating condition. Always follow the inspection and maintenance procedures and schedules described in the Owner's Manual.

WARNING

Failure to inspect or maintain the vehicle properly increases the possibility of an accident or equipment damage. Do not operate the vehicle if you find any problem. If a problem cannot be corrected by the procedures provided in this manual, have the vehicle inspected by a dealer.

Before using this vehicle, check the following points:

ITEM	CHECKS
Fuel	<ul style="list-style-type: none"> • Check fuel level in fuel tank. • Refuel if necessary. • Check fuel line for leakage
Engine oil	<ul style="list-style-type: none"> • Check oil level in engine. • If necessary, add recommended oil to specified level. • Check vehicle for oil leakage.

ITEM	CHECKS
Disc brake (If equipped)	<ul style="list-style-type: none"> • Check operation. • If soft or spongy, have dealer bleed hydraulic system. • Check brake pads for wear. Replace if necessary. • Check fluid level in reservoir. If necessary, add recommended brake fluid to specified level. • Check hydraulic system for leakage.
Drum brake (If equipped)	<ul style="list-style-type: none"> • Check operation. • Check brake shoes for wear. Replace if necessary.
Throttle grip	<ul style="list-style-type: none"> • Make sure that operation is smooth. • Check cable free play. • If necessary, have a dealer adjust cable free play and lubricate cable and grip housing.
Clutch lever	<ul style="list-style-type: none"> • Make sure that operation is smooth. • Check cable free play. • If necessary, have a dealer adjust cable free play and lubricate cable.

OPERATION AND IMPORTANT RIDING POINTS

STARTING THE ENGINE

1. Turn the key to "ON".
2. Put in neutral gear, or pull the clutch lever.
3. Start the engine by pushing the start switch.

WARNING

Do not start the engine indoor with bad ventilation or without ventilation. Do not leave a starting vehicle when no one else is around.

NOTICE

Do not run the engine in high speed when you do not drive the vehicle, or it will become overheating and damage its inner parts.

ITEM	CHECKS
Wheels and tires	<ul style="list-style-type: none"> • Check for damage. • Check tire condition and tread depth. • Check air pressure.
Brake levers	<ul style="list-style-type: none"> • Make sure that operation is smooth.
Brake pedal	<ul style="list-style-type: none"> • Lubricate pivots if necessary.
Sidestand, Mainstand (If equipped)	<ul style="list-style-type: none"> • Lubricate pivots if necessary.
Instruments, lights, signals and switches	<ul style="list-style-type: none"> • Check operation.

Read the Owner's Manual carefully to become familiar with all controls. If there is a control or function you do not understand, ask your dealer.

WARNING

Failure to familiarize yourself with the controls can lead to loss of control, which could cause an accident or injury.

ACCELERATION AND DECELERATION

The speed can be adjusted by opening and closing the throttle. To increase the speed, turn the throttle grip in direction (a). To reduce the speed, turn the throttle grip in direction (b).

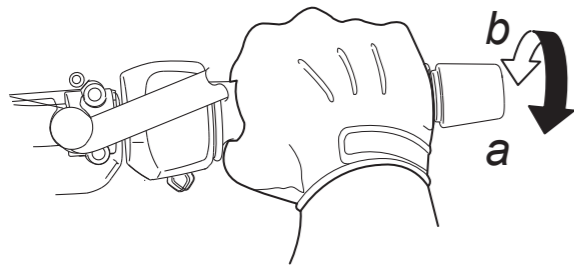

BRAKING

1. Close the throttle completely.
2. Apply both front and rear brakes simultaneously for safety concern.

WARNING

It is dangerous only to use either the front brake or rear brake which may cause skid or lose control. Be careful and use brakes properly when you drive on wet road or curved road.

ENGINE BREAK-IN

There is never a more important period in the life of your engine than the period between 0 and 1000 km. For this reason, you should read the following material carefully. Since the engine is brand new, do not put an excessive load on it for the first 1000 km. The various parts in the engine wear and fit to the correct operating clearances. During this period, prolonged full-throttle operation or any condition that might result in engine overheating. The engine should not be over revved and all the gears shall not be over 80% of red zone engine rpm; don't operate the throttle under a fully open position; change the gears in time to keep the engine rpm in reasonable

range. It is strongly suggested to use the vehicle very carefully during its running in period; also the rider has to be familiar to the performance.

PARKING

1. The vehicle should be parked on firm and flat road.
2. Turn the power key to the position "  " to stop the engine.
3. Remove ignition key from the switch after locking for security reason.

PERIODIC MAINTENANCE AND ADJUSTMENT

Periodic inspection, adjustment, and lubrication will keep your vehicle in the safest and most efficient condition possible. Safety is an obligation of the

vehicle owner/operator. The most important points of vehicle inspection, adjustment, and lubrication are explained on the following pages. The intervals given in the periodic maintenance and lubrication chart should be simply considered as a general guide under normal riding conditions. However, depending on the weather, terrain, geographical location, and individual use, the maintenance intervals may need to be shortened.

WARNING

Failure to properly maintain the vehicle or performing maintenance activities incorrectly may increase your risk of injury or death during service or while using the vehicle. If you are not familiar with vehicle service, have a dealer perform service.

NOTICE

- The annual checks must be performed every year, except if a kilometer-based maintenance, is performed instead.
- The vehicle may have different accessory for different market and some parts may not exist for common chart.

PERIODIC MAINTENANCE CHART

ITEM	CHECKS	ODOMETER READING					
		1000Km New	4000Km 3 months	7000Km 6 months	10000Km 9 months	13000Km 1 year	16000Km 15months
Fuel line	• Check fuel hoses for cracks or crack		●		●		
Spark plug	• Check condition. Clean and regap.		●		●		
	• Replace			●		●	
Valves	• Check/adjust valve clearance.	●		●		●	
Air filter element	• Inspect/cleaning/replace	●	●	●	●	●	●
Disc brake	• Check operation, fluid level and vehicle for fluid leakage.	●		●		●	
	• Inspect/replace brake pads.			●		●	
Drum brake	• Inspect/replace brake shoes.			●		●	
Wheels	• Check runout and damage.	●	●	●	●	●	●
Tires	• Check tread depth and damage.	●	●	●	●	●	●
	• Replace if necessary.	●	●	●	●	●	●
	• Check air pressure.	●	●	●	●	●	●
Chassis fasteners	• Make sure that all nuts, bolts and screws are properly tightened	●		●		●	
Front brake lever pivot shaft	• Lubricate with silicone grease.	●	●	●	●	●	●
Drive Chain	• Appropriate tightness • Appropriate lubrication	Per 1000km					

ITEM	CHECKS	ODOMETER READING					
		1000Km New	4000Km 3 months	7000Km 6 months	10000Km 9 months	13000Km 1 year	16000Km 15months
Rear brake lever pivot shaft	• Lubricate with silicone grease.	●	●	●	●	●	●
Side stand	• Check operation.	●	●	●	●	●	●
	• Lubricate.	●	●	●	●	●	●
Front fork	• Check operation and oil leakage.	●	●	●	●	●	●
Shock absorber	• Check operation and shock absorbers for oil leakage.	●	●	●	●	●	●
Engine oil	• Change.	●	●	●	●	●	●
	• Check oil level and vehicle for oil leakage.	●	●	●	●	●	●
Engine oil strainer	• Clean.				●		
Front and rear brake switches	• Check operation.	●	●	●	●	●	●
Moving parts and cables	• Lubricate.	●	●	●	●	●	●
Throttle grip	• Check operation and free play.	●	●	●	●	●	●
Housing and cable	• Adjust the throttle cable free play if necessary.	●	●	●	●	●	●
Lights, signals and switches	• Check operation.	●	●	●	●	●	●
	• Adjust headlight beam.	●			●		
NOTICE	More frequent inspection and maintenance are necessary in dusty area. Especially for air filter, it's suggested to do first maintenance in 500KM and clean air filter every 1000KM.						

CHECKING THE SPARK PLUG

The spark plug is an important engine component, which should be checked periodically, preferably by a dealer. Since heat and deposits will cause any spark plug to slowly erode, it should be removed and checked in accordance with the periodic maintenance. In addition, the condition of the spark plug can reveal the condition of the engine.

The porcelain insulator around the center electrode of the spark plug should be a medium-to-light tan (the ideal color when the vehicle is ridden normally). If the spark plug shows a distinctly different color, the engine could be operating improperly. Do not attempt to diagnose such problems yourself. Instead, have a dealer check the vehicle.

If the spark plug shows signs of electrode erosion and excessive carbon or other deposits, it should be replaced.

Before installing a spark plug, the spark plug gap should be measured with thickness gauge and, if necessary, adjusted to specification.

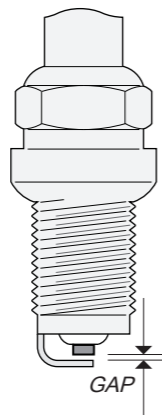

Type
BOSCH A7RC
Gap
0.6 - 0.7mm

Clean the surface of the spark plug gasket and its mating surface, and then wipe off any grime from the spark plug threads.

ENGINE OIL

The engine oil level should be checked before each ride. In addition, the oil must be changed at the intervals specified in the periodic maintenance and lubrication chart.

TO CHECK THE ENGINE OIL LEVEL

1. Start the engine, warm it up for several minutes, and then turn it off.

2. Wait a few minutes until the oil settles.
3. Hold the vehicle vertically. Inspect the engine oil level through the engine oil level lens on the right side on the engine.
4. If the engine oil is below the minimum level mark, add sufficient oil of the recommended type to refill it to the correct level.

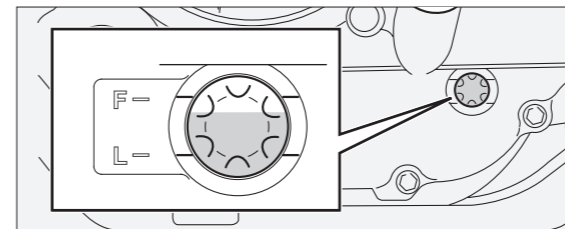

NOTICE

The engine oil should be between the minimum and maximum level marks.

TO CHANGE THE ENGINE OIL

1. Start the engine, warm it up for several minutes, and then turn it off.
2. Place an oil pan under the engine to collect the used oil.
3. Remove the engine oil filler cap and the engine oil drain bolt to drain the oil from the crankcase.
4. Install the washer and the engine oil drain bolt, and then tighten the drain bolt to the specified torque.
5. Refill with the specified amount of the recommended engine oil, and then install and tighten the oil filler cap.

Type
API SH, SAE10W-40, JASO MA
Without Oil Cooler Capacity
1.0L ± 0.1L
Equipped Oil Cooler Capacity
1.1L ± 0.1L

IDLE SPEED

Only use good quality fuel from gasoline station to prevent stain in the fuel from clogging the fuel pump strainer, or even the injectors.

The engine is required to be in normal operating temperature for accurate idling adjustment.

IDLING ADJUSTMENT

1. Keep the vehicle on flat surface.
2. Start the engine and warm up the engine for several minutes.
3. Clip the digital Tachometer to the spark plug cable.
4. If the idle speed is not in correct range, contact the nearest authorized dealers.

Idle speed: 1,500±100r/min

VALVE CLEARANCE

The valve clearance changes with use, resulting in improper air-fuel mixture and/or engine noise. To prevent this from occurring, the valve clearance must be adjusted by a dealer at the intervals specified in the periodic maintenance and lubrication chart.

The engine is required to be in normal operating temperature for accurate idling adjustment.

Valve clearance(Cold engine)

IN: 0.05 ~ 0.07mm EX: 0.05 ~ 0.07mm

AIR FILTER

The air filter element should be replaced and should be cleaned at the intervals specified in the periodic maintenance and lubrication chart.

REPLACING THE AIR FILTER ELEMENT

1. The air filter located under the seat, Remove the seat.
2. Park the vehicle on firm ground.
3. Remove the air filter case cover by removing the screws.
4. Pull the air filter element out.
5. Insert a new air filter element into the air filter case.
6. Install the air filter case cover by installing the screws.

A: Air Filter cover
B: Air Filter

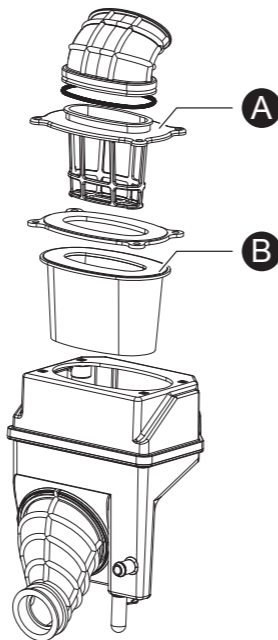

CHECKING THE THROTTLE CABLE FREE PLAY

The throttle cable free play should measure 3.0–5.0 mm at the throttle grip. Periodically check the throttle cable free play and, if necessary, have a dealer adjust it.

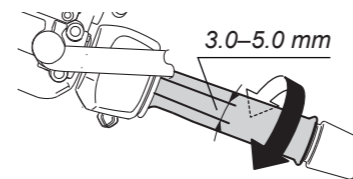

CHECKING THE CLUTCH FREE PLAY

The free play of clutch is measured from the free status of the lever, Adjust in following methods, if anything abnormal.

- (1) Loose the locknut.
- (2) Screw in or out adjusting bolt and adjusting screw to make required free stroke.
- (3) Tighten locknut.

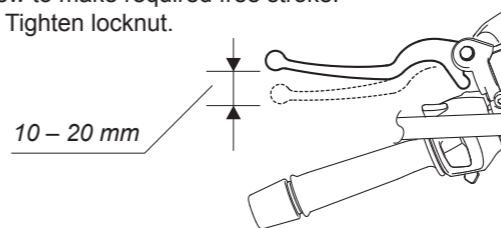

CHECKING THE FRONT BRAKE LEVER AND REAR BRAKE PEDAL FREE PLAY

The brake lever free play should measure 10-20 mm as shown. The brake pedal free play should measure 20-30 mm as shown. Periodically check the brake lever free play and, if necessary, have a dealer check the brake system.

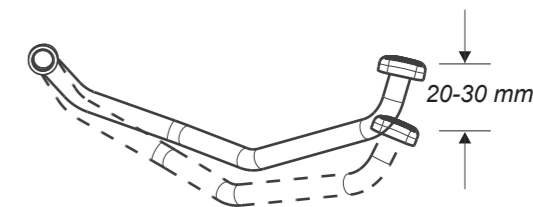
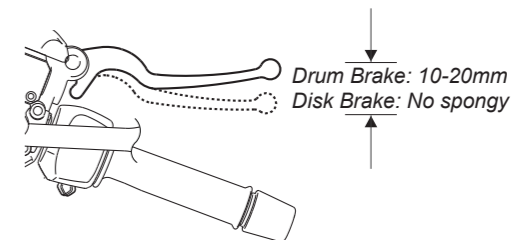

CHECK THE DRUM LIMIT (IF EQUIPPED)

Adjustment Nut

- Turn the adjustment nut on brake arm of rear wheels to adjust the free play of rear brake .
- Set down the rear brake pedal after adjusting until there is effective brake feeling.

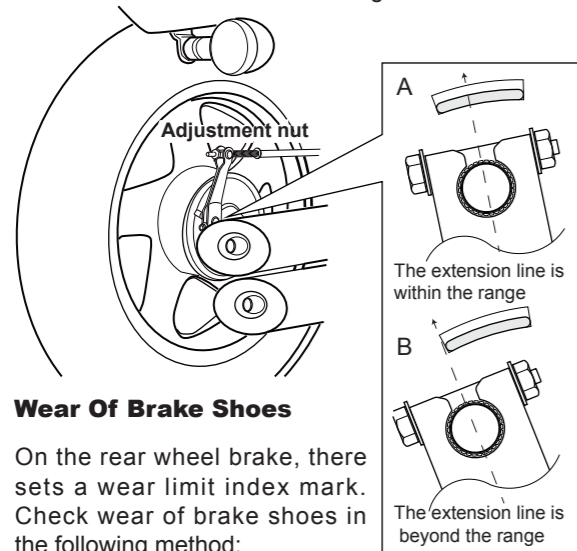

Wear Of Brake Shoes

On the rear wheel brake, there sets a wear limit index mark. Check wear of brake shoes in the following method:

1. Check if braking system is properly adjusted.

2. Check if braking function is normal, and if the limit index extension line is within the allowable range, as shown in Figure A.
3. If the limit index extension line is beyond the allowable range, as shown in Figure B, please go to your local distributor for replacement of components in the brake to ensure driving safety.

CHECKING THE BRAKE PADS

The front and rear brake pads must be checked for wear at the intervals specified in the periodic maintenance and lubrication chart.

Each brake pad is provided with wear indicator grooves, which allow you to check the brake pad wear without having to disassemble the brake. To check the brake pad wear, check the wear indicator grooves. If a brake pad has worn to the point that the wear indicator grooves were mostly disappeared, have a dealer replace the brake pads as a set.

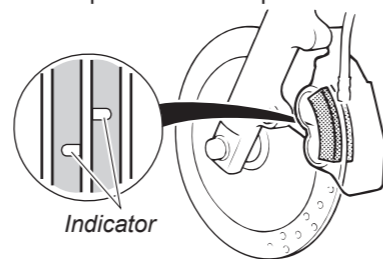

BRAKE FLUID

Brake system is tuned before delivery. Contact dealer if any problem.

Recommended brake fluid
DOT 4

⚠ WARNING

In case of drinking the brake fluid by mistake or contacting with eye or skin, wash with a large amount of water, and seek medical advice immediately if in a serious condition.

Don't forget to check the amount level in the brake fluid reservoir. Add appropriate brake fluid if necessary.

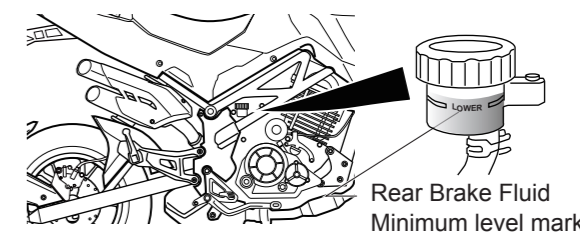
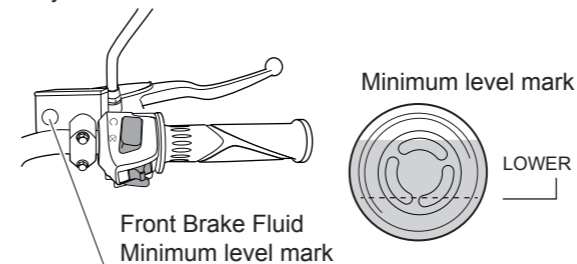

CHECKING THE BATTERY

Ask the dealer to add electrolyte for lead-acid battery. For MF battery, it's not required to inspect or add electrolyte.

Have a dealer charge the battery as soon as possible if it seems to have discharged. Keep in mind that the battery tends to discharge more quickly if the vehicle is equipped with optional electrical accessories.

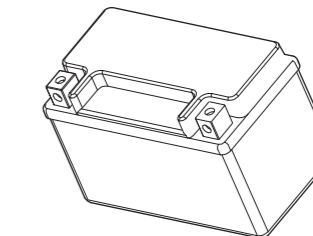

**12V6Ah (YTX7A-BS)
MF (Maintenance Free) Battery**

REPLACING THE FUSES AND BULBS

If a fuse or bulb for the individual circuits is blown, replace it as follows.

1. Turn the key to "OFF" and turn off the electrical circuit in question.
2. Remove the blown fuse or bulb, and then install a new fuse of the specified specification.

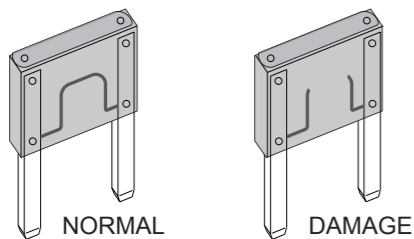

Main Fuse	20A
EFI System Fuse	15A

WARNING

Do not use a fuse or bulb of a higher amperage rating than recommended to avoid causing extensive damage to the electrical system and possibly a fire or problems.

Horn	12V 3A
Headlight bulb	LED 12V8/8W
Turn light	LED 12V3.6W
Front city light	LED 12V3.6W
Rear city light	LED 12V0.4W
Taillight bulb	LED 12V1.8W

TIRE

Inflation pressure and tire tread should be regularly checked. In order to ensure maximum safety and longer service life, inflation pressure requires more frequent routine check.

Tire Pressure

Insufficient tire pressure will not only accelerate wearing, but also have bad impact on driving stability such as making turning difficult. However, too high pressure will reduce the contact area between tire and ground, thus causing slipping or even getting out of control. Tire pressure should be kept in the stan-

ard range. Adjust the tire pressure under a "cold" condition.

TIRE INFORMATION	
COLD TIRE PRESSURE	
[FRONT] 190kpa(1.94kgf/cm ²)	[REAR] 210kpa(2.14kgf/cm ²)

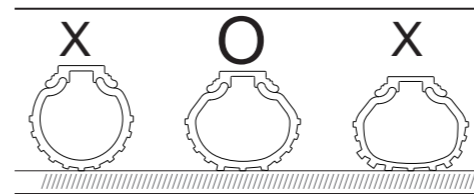

STORAGE

Short-term

Always store your vehicle in a cool, dry place and, if necessary, protect it against dust with a porous cover.

Long-term

Before storing your vehicle for several months:

1. Change engine oil.

2. Lubricate drive chain.
3. Drain fuel in fuel tank .Install the fuel tank cover again.
4. Detach the spark plug and add one teaspoon of (15~20cm³) clean engine oil to cylinder. and install the spark plug again.
5. Remove the battery. Keep the battery in proper place which can avoid freezing and the direct sunlight. Charge the battery or examine the electrolyte level(if equipped with lead-acid battery).
6. Clean and dry the vehicle. Wax the surface of the paint.
7. Inflate tire to the required pressure. Put the vehicle on a block to make two tires off the ground.
8. Cover the vehicle (no plastic or coating material) and keep it in the place consistent temperature and low humidity. Do not keep your vehicle under direct sunlight.

Use the vehicle after storage

1. Take off the cover and clean the vehicle. Change engine oil if you keep your vehicle for more than four months.
2. Examine the electrolyte level and charging as needed. Install the battery.
3. Wash away the anti-rust agent in fuel tank, and add new petrol into fuel tank.



SPECIFICATION

Size and Weight

Length 1770mm
Width 755mm
Height 1025mm
Wheelbase 1215mm
Dry Weight 116kg

Engine

Type Single-cylinder, Four-stroke, Air-cooled
Model 154FMI-7A
Bore × Stroke Ø54×58.8mm
Displacement 135ml
Ignition System Type TLI
Compression Ratio 9.8:1
Maximum Power 9.3kW/9000r/min

Maximum Torque 10.8N.m/7000r/min

Tire

Front tire 120/70-12
Rear tire 130/70-12

Fuel

Fuel Tank (include reserve tank) 7.2L
Fuel Type Regular unleaded gasoline only

Brake

Front Brake Type Disk Brake
Rear Brake Type Disk Brake